

Instructions



Pro Xp Auto Control Module

332989A
EN

User Interface for Pro Xp Auto Electrostatic Spray Guns.
For professional use only.



Important Safety Instructions

Read all warnings and instructions in this manual and the Graco Automatic Electrostatic Gun manuals.

Save these instructions.

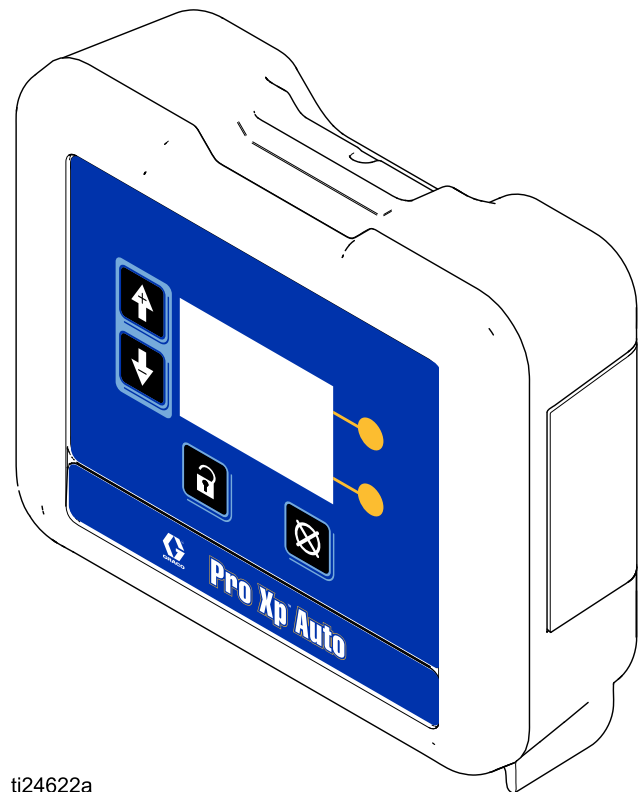

ti24622a



PROVEN QUALITY. LEADING TECHNOLOGY.





Contents

Warnings	3	Setup Screen 5	20
Models	5	Setup Screen 6	20
Overview	5	Event Code Troubleshooting	21
Related Manuals	5	Troubleshooting	23
Installation	6	Diagnostic Information	23
Cable Connections	6	Maintenance	24
Fiber Optic Connections	7	Update Software	24
Remote Mode I/O Connection	8	Replace Battery	24
Power Cord Connection	8	Repair	25
Grounding	9	Fiber Optic Cable Repair	25
Operation	10	Fiber Optic Bulkhead Installation	26
Module Screens	10	Parts	27
Preset	10	Accessories	28
Module Keys	10	Fiber Optic Cables for Gun	28
Icons	12	Fiber Optic Cable Repair and	
Screen Navigation and Editing	13	Accessories	28
Screen Map	14	Control Module I/O Cable Accessory	
Run Screens	16	Kits	28
Run Screen 1	16	Mounting Dimensions	29
Run Screens 2–5	17	Technical Data	29
Password Screen	17	Graco Standard Warranty	30
Setup Screens	18		
Setup Screens 1 and 2	18		
Setup Screens 3 and 4	19		

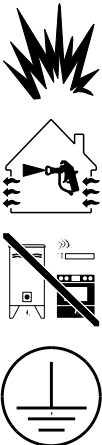
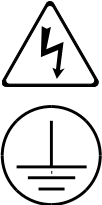
Warnings

The following warnings are for the setup, use, grounding, maintenance and repair of this equipment. The exclamation point symbol alerts you to a general warning and the hazard symbol refers to procedure-specific risks. When these symbols appear in the body of this manual or on warning labels, refer back to these Warnings. Product-specific hazard symbols and warnings not covered in this section may appear throughout the body of this manual where applicable.

 WARNING	
	<p>FIRE AND EXPLOSION HAZARD</p> <p>Flammable fumes, such as solvent and paint fumes, in work area can ignite or explode. To help prevent fire and explosion:</p> <ul style="list-style-type: none"> • Use equipment only in well ventilated area. • Eliminate all ignition sources; such as pilot lights, cigarettes, portable electric lamps, and plastic drop cloths (potential static arc). • Keep work area free of debris, including solvent, rags and gasoline. • Do not plug or unplug power cords, or turn power or light switches on or off when flammable fumes are present. • Ground all equipment in the work area. See Grounding instructions. • Use only grounded hoses. • Hold gun firmly to side of grounded pail when triggering into pail. Do not use pail liners unless they are antistatic or conductive. • Stop operation immediately if static sparking occurs or you feel a shock, Do not use equipment until you identify and correct the problem. • Keep a working fire extinguisher in the work area. <p>Static charge may build up on plastic parts during cleaning and could discharge and ignite flammable vapors. To help prevent fire and explosion:</p> <ul style="list-style-type: none"> • Clean plastic parts only in well ventilated area. • Do not clean with a dry cloth.
	<p>ELECTRIC SHOCK HAZARD</p> <p>This equipment must be grounded. Improper grounding, setup, or usage of the system can cause electric shock.</p> <ul style="list-style-type: none"> • Turn off and disconnect power at main switch before disconnecting any cables and before servicing or installing equipment. • Connect only to grounded power source. • Use only 3-wire extension cords. • Ensure ground prongs are intact on power and extension cords. • All electrical wiring must be done by a qualified electrician and comply with all local codes and regulations. • Do not expose to rain. Store indoors.

 <h1 style="margin: 0;">WARNING</h1>	
	<p>PERSONAL PROTECTIVE EQUIPMENT</p> <p>Wear appropriate protective equipment when in the work area to help prevent serious injury, including eye injury, hearing loss, inhalation of toxic fumes, and burns. This equipment includes but is not limited to:</p> <ul style="list-style-type: none"> • Protective eyewear, and hearing protection. • Respirators, protective clothing, and gloves as recommended by the fluid and solvent manufacturer.
 	<p>EQUIPMENT MISUSE HAZARD</p> <p>Misuse can cause death or serious injury.</p> <ul style="list-style-type: none"> • Do not operate the unit when fatigued or under the influence of drugs or alcohol. • Do not exceed the maximum working pressure or temperature rating of the lowest rated system component. See Technical Data in all equipment manuals. • Use fluids and solvents that are compatible with equipment wetted parts. See Technical Data in all equipment manuals. Read fluid and solvent manufacturer's warnings. For complete information about your material, request MSDS from distributor or retailer. • Do not leave the work area while equipment is energized or under pressure. • Turn off all equipment and follow the Pressure Relief Procedure when equipment is not in use. • Check equipment daily. Repair or replace worn or damaged parts immediately with genuine manufacturer's replacement parts only. • Do not alter or modify equipment. Alterations or modifications may void agency approvals and create safety hazards. • Make sure all equipment is rated and approved for the environment in which you are using it. • Use equipment only for its intended purpose. Call your distributor for information. • Route hoses and cables away from traffic areas, sharp edges, moving parts, and hot surfaces. • Do not kink or over bend hoses or use hoses to pull equipment. • Keep children and animals away from work area. • Comply with all applicable safety regulations.

Models

Model Number	Series	Description
24W035	A	Pro Xp Auto Control Module with software, mounting bracket and power supply included. Fiber optic cables must be purchased separately.
24X216	A	Pro Xp Auto Control Module. Module Only.

Overview

The Pro Xp Auto Control Module is for use only with Pro Xp Auto Electrostatic Gun smart models. The control module provides a user interface for up to two guns. Remote I/O allows communication with a Programmable Logic Controller (PLC). The display control module performs the following functions:

- Display the spraying voltage and current.
- Change the gun voltage setting.
- Display the gun turbine speed.
- Store spray presets.
- Communicate equipment faults to a PLC.
- Display and set maintenance totalizers.
- Use a PLC to select a spray profile.

Related Manuals

Manual	Description
333010	Pro Xp Auto Air Spray Gun
333011	Pro Xp Auto AA Spray Gun
333012	Pro Xp Auto Waterborne Air Spray Gun
333013	Pro Xp Auto Waterborne AA Spray Gun

Installation

Cable Connections

Ports 1 through 4 of the Pro Xp Auto Control Module are used in an automatic electrostatic gun installation.

Port	Description
1	Fiber Optic 1 (Gun 1)
2	Fiber Optic 2 (Gun 1)
3	Power Cord
4	Remote Mode I/O
5	Fiber Optic 1 (Gun 2)
6	Fiber Optic 2 (Gun 2)

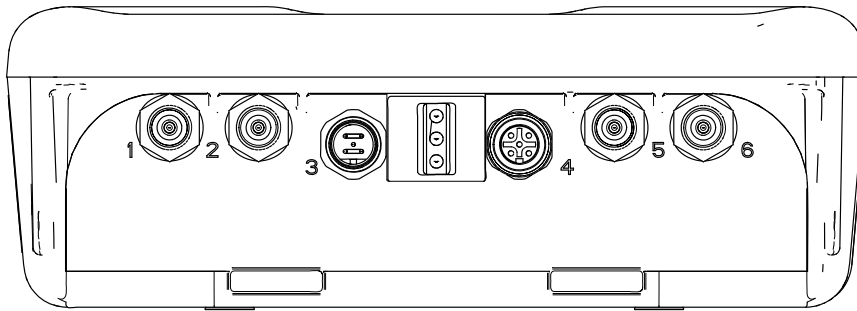

ti24621a

Figure 1 Pro Xp Auto Control Module

Fiber Optic Connections

(Operational on Smart models only)

NOTE: Only use Graco supplied fiber optic cable. See [Fiber Optic Cables For Gun, page 28](#)

The fiber optic cable connects the fiber optic ports on the gun manifold to Ports 1 and 2 on the Control Module.

For a 1 Gun System

1. Connect Port 1 of the gun 1 manifold to Port 1 of the Control Module.
2. Connect Port 2 of the gun 1 manifold to Port 2 of the Control Module.

For a 2 Gun System

1. Connect Port 1 of the gun 2 manifold to Port 5 of the Control Module.
2. Connect Port 2 of the gun 2 manifold to Port 6 of the Control Module.

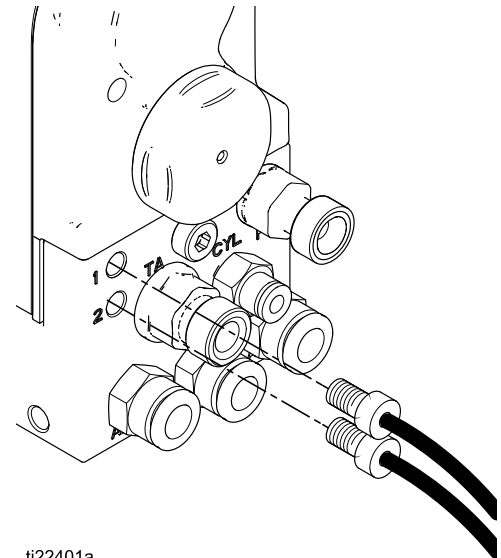

ti22401a

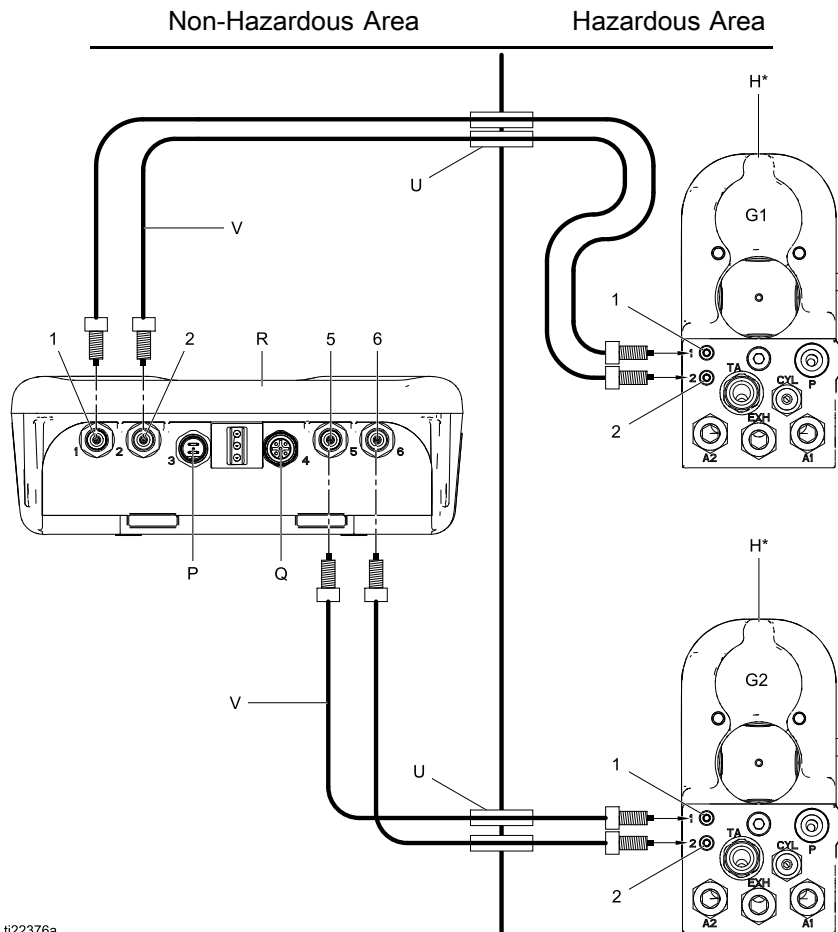

ti22376a

1	Port 1
2	Port 2
5	Port 5
6	Port 6
H	Pro Xp Auto Smart Gun
P	24 Volt Power Supply Connection
Q	Remote I/O Connection
R	Pro Xp Auto Control Module
U	Bulkhead (optional)
V	Fiber Optic Cable
G1	Gun 1
G2	Gun 2

Remote Mode I/O Connection

The use of the Remote Mode I/O capability is optional. Connector 4 on the Control Module is the remote mode I/O port.

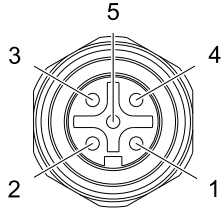

Figure 2 Connector 4 (I/O) Pinouts

Remote mode I/O cables are available separately. See [Control Module I/O Cable Accessory Kits, page 28](#)

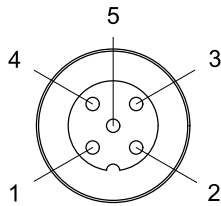

Figure 3 Cable Pin Information

Pin No.	Wire Color	Function
1	Brown	+24 VDC
2	White	Preset Select 1
3	Blue	Low kV Alarm Out
4	Black	Preset Select 2
5	Gray	GND

When remote mode is enabled, a Preset can be selected by applying the following signals to Preset Select 1 (pin 2) and Preset Select 2 (pin 4) of connector 4.

Preset Select 2 State	Preset Select 1 State	Encoding	Selected Preset
GND	GND	00	1
GND	+24 VDC or Floating	01	2
+24 VDC or Floating	GND	10	3
+24 VDC or Floating	+24 VDC or Floating	11	4





During normal operation, Low kV Alarm Out (pin 3) is at 0 V. When a low voltage alarm occurs, Low kV Alarm Out (pin 3) is at 24 VDC. This occurs regardless of remote mode setting.

NOTE: Low kV Alarm Out (pin 3) will read ~18 V when inactive in an unloaded measurement.

Power Cord Connection

1. Connect the adapter cord (supplied) to Port 3 on the control module.
2. Connect the 3-wire power cord (supplied) to the adapter.
3. Plug the 3-wire power cord into a grounded electrical outlet.

Grounding

					
<p>The equipment must be grounded to reduce the risk of static sparking and electric shock. Electric or static sparking can cause fumes to ignite or explode. Improper grounding can cause electric shock. Grounding provides an escape wire for the electric current.</p>					

The Pro Xp Auto Control Module is grounded by an adapter and a 3-wire power cord (supplied) connected to a grounded electrical outlet. If the module is mounted to a bracket, connect a separate ground wire to the bracket using a screw. Connect the other end to a true earth ground.

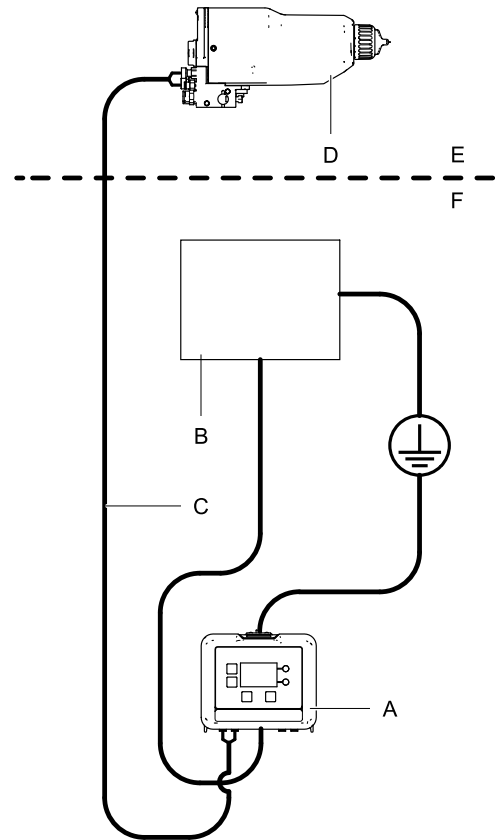

ti24643a

A	Pro Xp Auto Control Module
B	Power Supply
C	Fiber Optic Cable
D	Pro Xp Auto Electrostatic Gun
E	Hazardous Area
F	Non-Hazardous Area

Operation

Module Screens

The Pro Xp Auto Control Module has two sets of screens: Run and Setup. For detailed information see [Run Screens, page 16](#), and [Setup Screens, page 18](#).

Press  to toggle between the Run screens and the Setup screens.

Preset

The presets can be used to store gun parameters. Four presets are available for each gun. See [Setup Screens 1 and 2, page 18](#) to view and change preset parameters.

Module Keys

The control module display and keys are displayed below. Table 1 explains the function of the membrane keys on the control module. As you move through the screens, you will notice that most information is communicated using icons rather than words to simplify global communication. The detailed screen descriptions in [Run Screens, page 16](#), and [Setup Screens, page 18](#), explain what each icon represents. The two softkeys are membrane buttons whose function correlates with the screen content to the immediate left of the button.

NOTICE



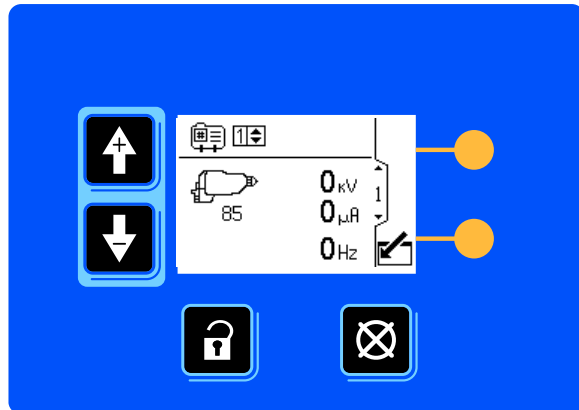





To prevent damage to the softkey buttons, do not press the buttons with sharp objects such as pens, plastic cards, or fingernails.



ti22420a















Figure 4 Control Module Keypad and Display















Table 1 Module Keys

Membrane Keys	Softkeys
 <p>Press to toggle between Run screens and Setup screens.</p>	 <p><i>Enter Screen.</i> Highlight data that can be edited. Also changes the function of the Up/Down arrows so they move between data fields on the screen, rather than between screens.</p>
 <p><i>Error Reset:</i> Use to clear event after cause has been fixed. Also used to cancel data entered and return to original data.</p>	 <p><i>Exit Screen.</i> Exit data editing.</p>
 <p><i>Up/Down Arrows:</i> Use to move between screens or fields on a screen, or to increment or decrement the digits in a settable field.</p>	 <p><i>Enter.</i> Press to activate a field for editing or to accept the highlighted selection on a dropdown menu.</p>
 <p><i>Softkeys:</i> Use varies by screen. See columns at right.</p>	 <p><i>Right.</i> Move to the right when editing number fields. Press again to accept the entry when all digits are correct.</p>

Icons

As you move through the screens, you will notice that most information is communicated using icons rather than words to simplify global communication. The detailed screen descriptions in [Run Screens, page 16](#), and [Setup Screens, page 18](#), explain what each icon represents.







Screen Icons	
 Alarm	 Preset Number
 Deviation	 kiloVolts/Voltage
 Advisory	 microAmperes/Current
 Display ID	 Hertz/Frequency
 Electrostatic Gun	 Electrostatic Gun Active
Gun 1	
Gun 2	
Number of Guns	
 Remote Mode	 Remote Mode Enabled
 Preset 1 Active	 Preset 2 Active

Screen Icons	
 Preset 3 Active	 Preset 4 Active
 Low kV Alarm Setpoint	 Maximum kV Setpoint
 Target Days	 Remaining Days
 Tip/Nozzle	 Aircap
 Turbine	 Check Mark/Optional
 Calendar	 Clock
 Units	 Maintenance
 Password	





Screen Navigation and Editing

Refer to this section if you have questions about screen navigation or about how to enter information and make selections.





All Screens

1. Use   to move between screens.
2. Press  to enter a screen. The first data field on the screen will highlight.
3. Use   to highlight the data you wish to change.
4. Press  to edit.

Drop Down Field



1. Use   to highlight the correct choice from the dropdown menu.
2. Press  to select.
3. Press  to cancel.

Number Field











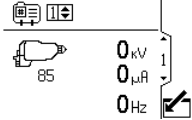
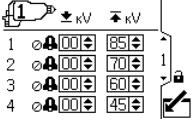



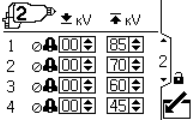

1. The first digit will be highlighted. Use   to change the number.
2. Press  to move to the next digit.
3. When all digits are correct, press  again to accept.
4. Press  to cancel.

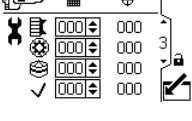

Check Box Field

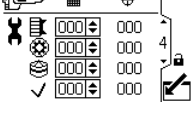
A check box field is used to enable or disable features in the software.

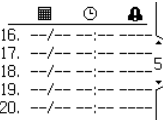
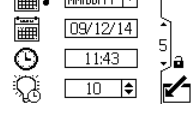
1. Press  to toggle between  and an empty box.
2. The feature is enabled if a  is in the box.

Screen Map

Run Screens	Setup Screens
<p>Run Screen 1, page 16</p> 	<p>Setup Screen 1, page 18</p> 
	
<p>Run Screens 2-5, page 17</p> 	<p>Setup Screen 2, page 18</p>  <p>(2 gun systems only)</p>
	
<p>Run Screens 2-5, page 17</p> 	<p>Setup Screen 3, page 19</p> 
	
<p>Run Screens 2-5, page 17</p> 	<p>Setup Screen 4, page 19</p>  <p>(2 gun systems only)</p>
	
<p>Run Screens 2-5, page 17</p> 	<p>Setup Screen 5, page 20</p> 
	

Run Screens	Setup Screens
	<p data-bbox="1003 247 1312 279">Setup Screen 6, page 20</p> 
	 

Run Screens

When in Run Mode, the display shows the gun parameters and the most recent 20 events. The active gun preset can also be changed.

Run Screen 1

Use this screen to view the gun spraying voltage in kilovolts (kV), the spraying current in microamps (μ A), and turbine frequency in hertz (Hz). The active maximum spraying voltage is shown under the gun icon. The active gun preset is operator selectable to presets 1-4. The maximum voltage setting for the presets can be changed on setup screen 1. If the device is in remote mode, the remote mode icon shows up next to the preset select control. When the gun has turbine power, the numbers will show non-zero. When in two gun mode, the information for both guns is shown.

NOTE: Only one preset is selected. Make sure your presets are properly set up for both guns.

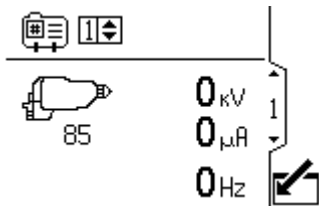

Figure 5 Run Screen 1 in Manual Mode (1 gun system)

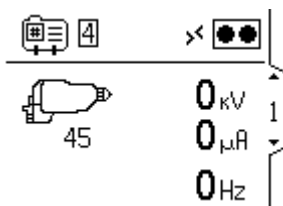

Figure 6 Run Screen 1 in Remote Mode (1 gun system)

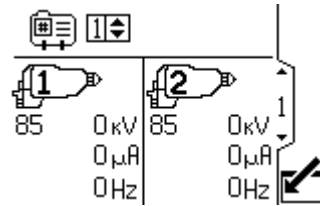

Figure 7 Run Screen 1 in Manual Mode (2 gun system)

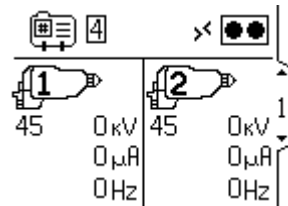



Figure 8 Run Screen 1 in Remote Mode (2 gun system)

Run Screen 1 Key	
	Enter the screen to edit (manual mode only).
	Voltage Preset; operator selectable. Changes the maximum spraying voltage of the gun. Presets 1-4.
	Electrostatic Gun. The number beneath the icon is the active maximum spraying voltage.
	Also displays spraying voltage (kV) and spraying current (μ A). NOTE: The number shown inside the gun is the gun number.
	Electrostatic Gun Active
	Exit the screen (manual mode only).

Run Screens 2-5

Use Run Screens 2-5 to view the log of recent events. The latest 20 events are viewable, with date and time.

NOTE: Run Screen 2 is shown as an example. Use the arrow keys   to scroll through the screens.

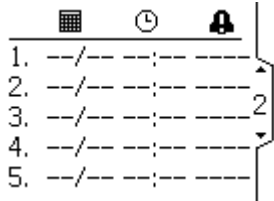





Figure 9 Run Screen 2

Run Screen 2 Key	
	Date the event occurred.
	Time the event occurred.
	Indicates an event occurred.

Password Screen

If a password has been set, the Password Screen displays when  is pressed from any Run screen. Enter password to enable entry to the Setup screens. Set the password to 0000 to disable password protection. See [Setup Screens 3 and 4, page 19](#) to set or change the password.

NOTE: If you forget your password, use 1492 to gain access and enter a new password.

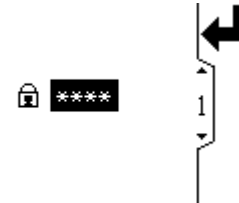



Figure 10 Password Screen

Key	
	Press to activate a field for editing or to accept the highlighted section on a dropdown menu.
	Move to the right when editing number fields. Press again to accept the entry when all digits are correct.

Setup Screens

The Setup Mode is used to set up a password (if desired) and to set parameters for controlling and monitoring the electrostatic gun. See [Screen Navigation and Editing, page 13](#) for information on how to make selections and enter data.

Setup Screens 1 and 2

Use this screen to view and change preset parameters. Presets can be used to store gun parameters. Four presets are available for each gun.

- The first column shows the preset number (1-4).
- The second column shows the minimum voltage setpoint for the preset, settable (in increments of 5) between 0 and 50 kV for an 85 kV gun and between 0 and 40 for a 60 kV gun. If the spraying voltage falls below the set value, the system will alarm. Setting the control to zero disables the alarm.
- The third column shows the maximum voltage for the preset, settable between 40 kV and 85 kV (in increments of 5). Setting to anything other than 85 kV puts the gun into a low voltage mode. For waterborne guns, voltage is settable between 30 kV and 60 kV.
- **NOTE:** An 85kV gun's normal high voltage reading is 60–70 kV. If a ball end high voltage measurement probe is used, the gun voltage will rise to about 85 kV. This will happen with all resistive electrostatic guns.
- In two gun operation, a second screen is shown for Gun #2 as indicated by the gun icon in the upper left portion of the screen.

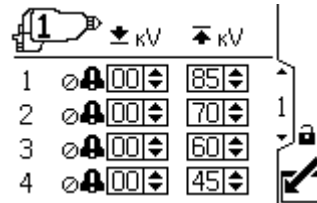

Figure 11 Setup Screen 1

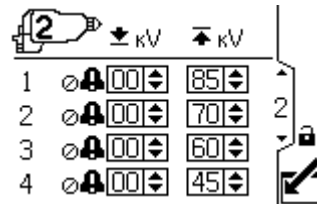

Figure 12 Setup Screen 2 (2 gun system only)

Setup Screen 1 Key	
	Enter the screen.
	Press to activate a field for editing or to accept the highlighted selection on a dropdown menu.
	Move to the right when editing number fields. Press again to accept the entry when all digits are correct.
	Preset number.
	Set the maximum voltage setpoint for the preset.
	Set the minimum voltage for the low voltage alarm for the preset.
	Exit data editing.
	Denotes which gun the settings belong to

Setup Screens 3 and 4

Use this screen to view and reset the maintenance totalizers. Maintenance totalizer units, shown on this Setup Screen, are always in elapsed calendar days. An Advisory is issued when the maintenance totalizer reaches zero. To restart the timer, navigate to this screen, edit the setpoint, and then clear the advisory using the Error Reset button. As these timers are based on the display date, the maintenance totalizers must be reset if the date is changed. In two gun operation, a second screen is shown for Gun #2 as indicated by the gun icon in the upper left portion of the screen.

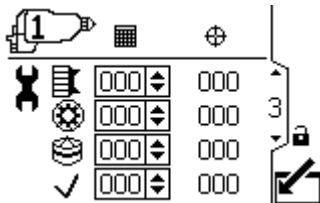

Figure 13 Setup Screen 3

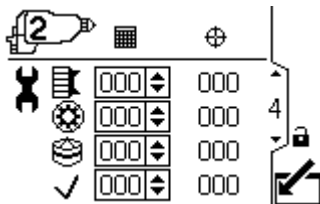











Figure 14 Setup Screen 4 (2 gun system only)

Setup Screen 3 and 4 Key	
	Enter the screen.
	Press to activate a field for editing or to accept the highlighted selection on a dropdown menu.
	Move to the right when editing number fields. Press again to accept the entry when all digits are correct.
	Maintenance setpoint in calendar days.
	Maintenance totalizer – Counts down from setpoint to zero.
	Aircap maintenance totalizer.
	Tip/Nozzle maintenance totalizer.
	Alternator maintenance totalizer.
	Check/Optional maintenance totalizer
	Exit data editing.
	Denotes which gun the settings belong to

Setup Screen 5

Use this screen to set date format, date, time, and backlight timeout.

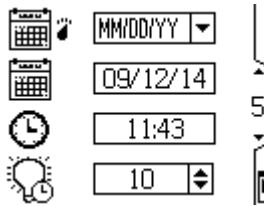

Figure 15 Setup Screen 5

Setup Screen 5 Key	
	Enter the screen.
	Press to activate a field for editing or to accept the highlighted selection on a dropdown menu.
	Move to the right when editing number fields. Press again to accept the entry when all digits are correct.
	Select your preferred date format from the dropdown menu.
	MM/DD/YY
	DD/MM/YY
	YY/MM/DD
	Set the current date.
	Set the current time.
	Set the display backlight timeout (in minutes). A setting of zero means that the backlight is on continuously.
	Exit data editing.

Setup Screen 6

Use this screen to activate or change a password that will be required to access the Setup screens and to enable/disable remote voltage preset control. This screen also displays the software version. This screen is also used to select the number of guns for the system (1 or 2).

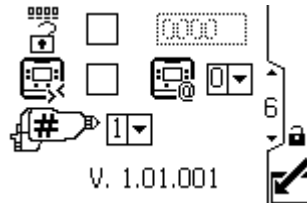





Figure 16 Setup Screen 6

Setup Screen 6 Key	
	Enter the screen.
	Press to activate a field for editing or to accept the highlighted selection on a dropdown menu.
	Move to the right when editing number fields. Press again to accept the entry when all digits are correct.
	Enable/Disable the password with the checkbox control. Enter the desired password (if enabled).
	Enable/Disable remote voltage preset control.
	Exit data editing.
	Choose 1 for a 1 gun system, 2 for a 2 gun system.
	Display ID setting. For advanced installations only.







Event Code Troubleshooting

Event codes can take four forms:



- Alarm : critical event; must be addressed immediately.
- Deviation : critical event; requires attention.
- Advisory : non-critical event; requires attention.
- Record: Useful information for troubleshooting.



To clear an event code, press .

Icon	Code	Gun	Description	How to Correct and Clear
	V1D1	Gun 1	Low kV Alarm. The low kV alarm displays when the spraying voltage drops below the user-set minimum.	Decrease conductivity of paint or increase distance to part. Press clear button to clear alarm.
	V1D2	Gun 2		
	CBD1	Gun 1	Fiber Optic Communication Deviation. The fiber optic communication alarm displays when the display receives bad data from the gun.	Check fiber optic cables and gun power. Press clear button to clear alarm.
	CBD2	Gun 2		
	CAI1	Gun 1	Power Supply Communication Lost Deviation. The gun fiber optic board loses communication with the gun power supply.	Check internal gun connections and verify turbine air pressure. Press clear button to clear alarm.
	CAI2	Gun 2		
	MD11	Gun 1	Turbine Maintenance Advisory. The turbine maintenance totalizer target value was reached.	Perform maintenance and reset maintenance totalizer. Press clear button to clear alarm. Alarm will not clear until maintenance totalizer has been reset.
	MD21	Gun 2		
	MD12	Gun 1	Tip/Nozzle Maintenance Advisory. The tip/nozzle maintenance totalizer target value was reached.	Perform maintenance and reset maintenance totalizer. Press clear button to clear alarm. Alarm will not clear until maintenance totalizer has been reset.
	MD22	Gun 2		
	MD13	Gun 1	Aircap Maintenance Advisory. The aircap maintenance totalizer target value was reached.	Perform maintenance and reset maintenance totalizer. Press clear button to clear alarm. Alarm will not clear until maintenance totalizer has been reset.
	MD23	Gun 2		
	MD14	Gun 1	Check/Optional Maintenance Advisory. The check/optional maintenance totalizer target value was reached.	Perform maintenance and reset maintenance totalizer. Press clear button to clear alarm. Alarm will not clear until maintenance totalizer has been reset.
	MD24	Gun 2		

Event Code Troubleshooting

Icon	Code	Gun	Description	How to Correct and Clear
	K2D1 K2D2	Gun 1 Gun 2	Turbine Frequency Low Advisory. Turbine frequency below 400Hz at 85kV or below 325Hz at lower voltage.	Increase turbine air pressure. Press clear button to clear alarm.
	K3D1 K3D2	Gun 1 Gun 2	Turbine Frequency High Advisory. Turbine frequency above 750Hz at 85kV or above 675Hz at lower voltage.	Decrease turbine air pressure. Press clear button to clear alarm.
	WMC1		Invalid Hardware The invalid hardware alarm displays when the display control module is not the correct version to work with the Pro Xp Auto.	Verify the proper display control module part number is being used. See parts page for valid part numbers.
	EAD1		Preset 1 Activated Record. This record shows when preset 1 was activated.	No action required. Shown on the event log for information only.
	EAD2		Preset 2 Activated Record. This record shows when preset 2 was activated.	No action required. Shown on the event log for information only.
	EAD3		Preset 3 Activated Record. This record shows when preset 3 was activated.	No action required. Shown on the event log for information only.
	EAD4		Preset 4 Activated Record. This record shows when preset 4 was activated.	No action required. Shown on the event log for information only.

Troubleshooting

Problem	Cause	Solution
Display is completely dark.	Power is not on.	Turn power supply on.
	Loose or disconnected power cable.	Tighten or connect cable.
Gun is on but no numbers are showing.	Incorrect fiber optic cable connections.	Check connections. See Fiber Optic Connections, page 7 .
	Bad fiber optic cable.	Check cable for damage. Replace or repair fiber optic cable. See Fiber Optic Cable Repair, page 25
	Gun board error.	Turn off turbine air, then turn back on to cycle power to gun board.
Clock stops functioning	Dead battery.	Replace battery. See Replace Battery, page 24
Display has power but does not function.	Hardware failure.	Replace display module.

Diagnostic Information

The LEDs on the bottom of the control module give important information about system function.

LED Signals

Signal	Description
Green On	Control module is powered up.
Yellow	Internal communication in progress.
Red solid	Control module failure. See Troubleshooting, page 23 .
Red flashing	Software is updating.
Red flashing slowly	Token error; remove token and upload software token again.



Maintenance

Update Software

Manual 3A1244 will accompany any necessary software updates. Follow all instructions in Manual 3A1244 to update your control module software.

Replace Battery

Replace the battery only if the clock stops functioning after disconnecting power or a power failure.

					
Sparkling can occur when changing the battery. Replace the battery only in a non-hazardous location, away from flammable fluids or fumes.					

NOTICE
To avoid damaging the circuit board, wear a grounding strap.

1. Disconnect power.
2. Remove the module from the bracket.
3. Attach grounding strap.
4. Remove 4 screws, and then remove the access cover.

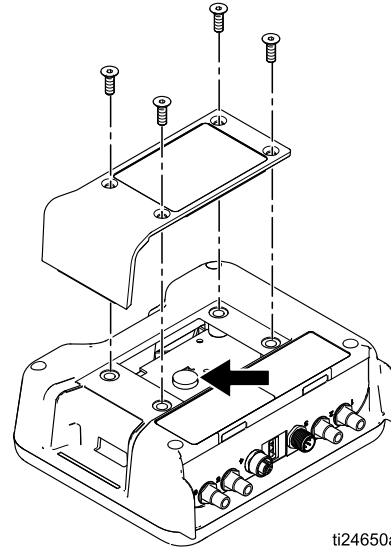

5. Use a flathead screwdriver to pry out the old battery.

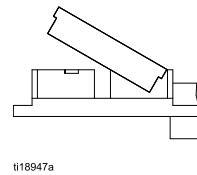

NOTE: Dispose of battery properly in an approved container and according to applicable local guidelines.

6. Replace with new battery. Ensure battery fits under connector tabs before snapping other end in place.

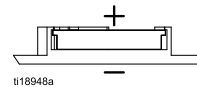

NOTE: Use only Panasonic CR2032 batteries for replacement.

7. Reassemble access cover and screws.
8. Snap the module back into the bracket.

Repair

Fiber Optic Cable Repair

NOTE: Fiber optic repair kit 24W875 includes fittings for one double strand fiber optic cable and a cutter tool. Cutter tool 24W823 may also be purchased separately.

1. Make a clean cut to the ends of the cable using fiber optic cutter tool (8). Ensure the ends of the cable are equal length.
2. Add fiber optic fitting parts (2) to cable as shown. Keep track of mounting ends using fiber optic markers (4, 5).
3. For the end of the cable that connects to the Pro Xp Auto Control Module or to a bulkhead, thread on fiber optic nut (3) to length A equaling .31 in (5/16") (7.9 mm).
4. For the end of the cable that connects to the Pro Xp Auto gun, the length must be adjusted for your gun model. For rear manifold gun models (model numbers LA1xxx or HA1xxx) adjust length A to .31 in (7.9 mm). For bottom manifold gun models (model numbers LA2xxx or HA2xxx) adjust length A to 1.02 in (25.9 mm).

When using a Graco provided cable, Dimension A is set at the factory.

Fiber Optic Cable Connector Adjustment		
FO Cable Kit	Description	Dimension A
24X003◆	Fiber Optic Cable, Rear Manifold, 25 ft	0.31 in (7.9 mm)
24X004◆	Fiber Optic Cable, Rear Manifold, 50 ft	0.31 in (7.9 mm)
24X005◆	Fiber Optic Cable, Rear Manifold, 100 ft	0.31 in (7.9 mm)
24X006◆	Fiber Optic Cable, Bottom Manifold, 25 ft	1.02 in (25.9 mm)
24X007◆	Fiber Optic Cable, Bottom Manifold, 50 ft	1.02 in (25.9 mm)
24X008◆	Fiber Optic Cable, Bottom Manifold, 100 ft	1.02 in (25.9 mm)

◆ Cutter tool 24W823 is included in these cable kits.

NOTICE

Fiber optic cable ends must be cut clean and square to ensure proper function. Dimension A must be adjusted for the gun model used to ensure proper function.

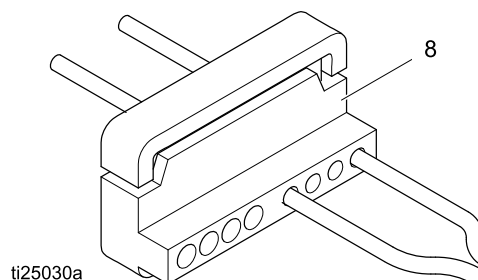

Fiber Optic Bulkhead Installation

Stainless Steel Bulkhead

Accepts Graco fiber optic cable fittings. Fits 1/2 inch (13 mm) panel hole.

24W876 Stainless Steel Bulkhead Installation

1. Drill a 1/2 in. to 9/16 in (12.7 mm to 14.2 mm) hole in booth wall or panel to allow bulkhead to pass through.
2. Make sure fiber optic cables meet dimensions as outlined in fiber optic repair instructions.
3. Insert bulkhead (6) into hole and attach nut (7) on either side. Thread in fiber optic cable fitting (2) until it bottoms out. Do not force cable further. Make sure cable marker numbers match to ensure proper communication.
4. Repeat for second side of communications.

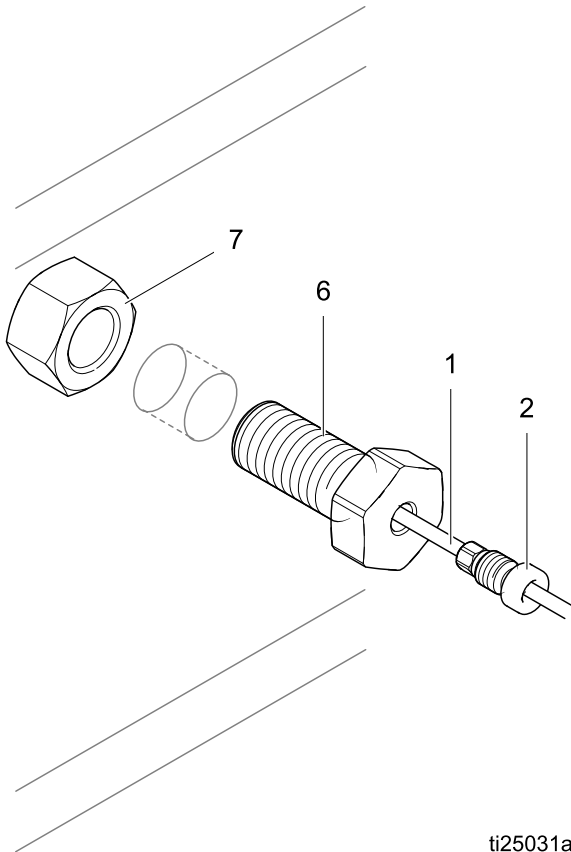

Plastic Bulkhead

Accepts bare fiber optic cable. Fits 5/15" (8 mm) panel hole.

24W877 Plastic Bulkhead Installation

1. Drill a 5/16 in. to 3/8 in (7.9 mm to 9.5 mm) hole in booth wall or panel to allow bulkhead to pass through.
2. Make a clean cut to the ends of the cable using fiber optic cutter tool (8). Ensure the ends of the cable are equal length.
3. Insert bulkhead (6) into hole and attach nut (7) on either side. Insert cable into bulkhead and tighten cinch nut down to a snug fit.
4. Repeat for second side of communications.

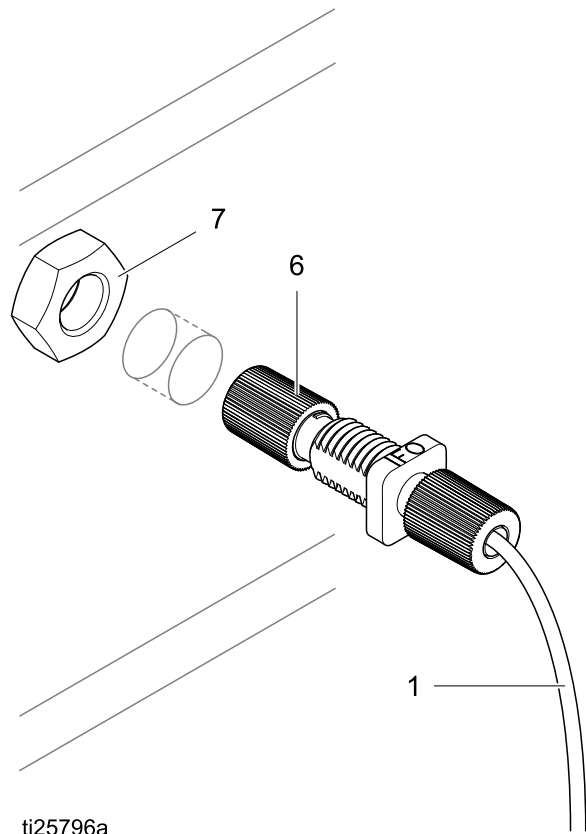

Parts

24W035 — Pro Xp Auto Control Module Kit

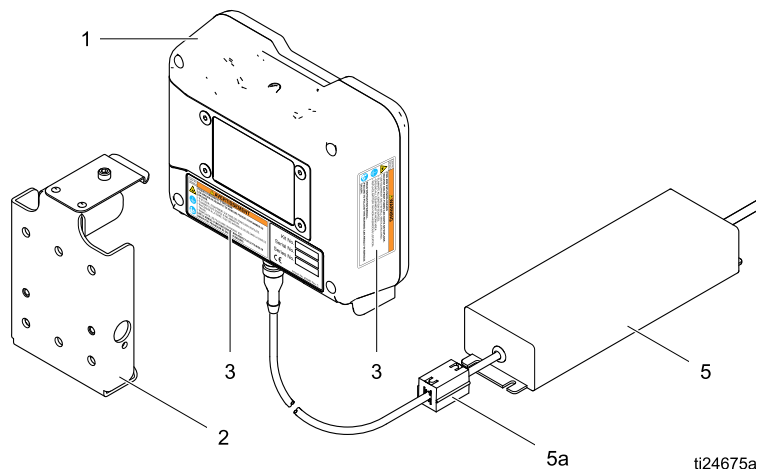

Figure 17

Ref.	Part	Description	Qty.
1	24X216	Pro Xp Auto Control Module	1
2	277853	Mounting Bracket	1
3▲	16P265	Warning Label	1
5	24W880	Power Supply with Cord Set	1
5a	119253	Ferrite	1
6	244524	Ground Wire Assembly (not shown)	1

▲ Replacement Danger and Warning labels, tags, and cards are available at no cost.

NOTE: The power supply has a IEC 320–C13 male connector for a power cord. A North American power cord with a NEMA 5–15P plug is included. A US power cable is provided with kits 24W035 and 34W880. Contact your local sales person if a global power cable is required.

Accessories

Fiber Optic Cables for Gun

Models With Rear Manifolds (Model numbers LA1xxx or HA1xxx)

Kit Number	Description
24X003	Fiber Optic Cable, Rear Manifold, 25 ft
24X004	Fiber Optic Cable, Rear Manifold, 50 ft
24X005	Fiber Optic Cable, Rear Manifold, 100 ft

Models With Bottom Manifolds (Model numbers LA2xxx or HA2xxx)

Kit Number	Description
24X006	Fiber Optic Cable, Bottom Manifold, 25 ft
24X007	Fiber Optic Cable, Bottom Manifold, 50 ft
24X008	Fiber Optic Cable, Bottom Manifold, 100 ft

Fiber Optic Cable Repair and Accessories

Kit Number	Description
24W875	Fiber Optic Repair Kit — Includes fittings for one double-strand fiber optic cable and a cutter tool.
24W876	Fiber Optic Bulkhead Fitting, SST — Qty 2. Accepts Graco fiber optic cable fittings. Fits 1/2 inch (13 mm) panel hole.
24W877	Fiber Optic Bulkhead, Plastic — Qty. 2. Accepts bare fiber optic cable. Fits 5/16 inch (8mm) panel hole
24W823	Fiber Optic Cutter Tool — Qty. 3.
24X009	Marker Numbers for Fiber Optic Cable Ends — Pack of 30 (#1 and #2)

Control Module I/O Cable Accessory Kits

Kit Number	Description
24W881	I/O cable, 50 ft
24W882	I/O cable, 100 ft

Mounting Dimensions

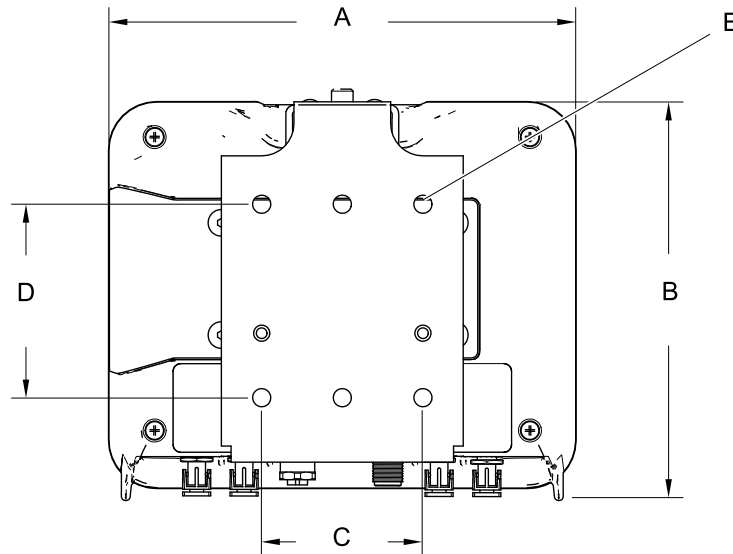

ti17985a

A Overall Width in. (mm)	B Overall Height in. (mm)	Overall Depth in. (mm)	Mounting Dimensions Width (C) x Height (D) in. (mm)	E Mounting Hole Size in. (mm)
7.2 (183)	6.0 (152)	2.8 (71)	2.5 x 3.0 (64 x 76)	0.28 (7)

Technical Data

	US	Metric
Operating Temperature	32° to 122°F	0° to 50°C
Storage Temperature	-22° to 140°F	-30° to 60°C
Weight		
Control Module	1 lb	0.45 kg
Mounting Bracket	1 lb	0.45 kg
Power Connection	Straight IEC 320-C13 male connector and a North American NEMA 5-15P male plug are provided.	
External Power Requirements	100-240 Vac, 50/60 Hz, 0.8 amps	
Humidity	0 to 95 percent, non-condensing	
Display housing is solvent resistant.		

Graco Standard Warranty

Graco warrants all equipment referenced in this document which is manufactured by Graco and bearing its name to be free from defects in material and workmanship on the date of sale to the original purchaser for use. With the exception of any special, extended, or limited warranty published by Graco, Graco will, for a period of twelve months from the date of sale, repair or replace any part of the equipment determined by Graco to be defective. This warranty applies only when the equipment is installed, operated and maintained in accordance with Graco's written recommendations.

This warranty does not cover, and Graco shall not be liable for general wear and tear, or any malfunction, damage or wear caused by faulty installation, misapplication, abrasion, corrosion, inadequate or improper maintenance, negligence, accident, tampering, or substitution of non-Graco component parts. Nor shall Graco be liable for malfunction, damage or wear caused by the incompatibility of Graco equipment with structures, accessories, equipment or materials not supplied by Graco, or the improper design, manufacture, installation, operation or maintenance of structures, accessories, equipment or materials not supplied by Graco.

This warranty is conditioned upon the prepaid return of the equipment claimed to be defective to an authorized Graco distributor for verification of the claimed defect. If the claimed defect is verified, Graco will repair or replace free of charge any defective parts. The equipment will be returned to the original purchaser transportation prepaid. If inspection of the equipment does not disclose any defect in material or workmanship, repairs will be made at a reasonable charge, which charges may include the costs of parts, labor, and transportation.

THIS WARRANTY IS EXCLUSIVE, AND IS IN LIEU OF ANY OTHER WARRANTIES, EXPRESS OR IMPLIED, INCLUDING BUT NOT LIMITED TO WARRANTY OF MERCHANTABILITY OR WARRANTY OF FITNESS FOR A PARTICULAR PURPOSE.

Graco's sole obligation and buyer's sole remedy for any breach of warranty shall be as set forth above. The buyer agrees that no other remedy (including, but not limited to, incidental or consequential damages for lost profits, lost sales, injury to person or property, or any other incidental or consequential loss) shall be available. Any action for breach of warranty must be brought within two (2) years of the date of sale.

GRACO MAKES NO WARRANTY, AND DISCLAIMS ALL IMPLIED WARRANTIES OF MERCHANTABILITY AND FITNESS FOR A PARTICULAR PURPOSE, IN CONNECTION WITH ACCESSORIES, EQUIPMENT, MATERIALS OR COMPONENTS SOLD BUT NOT MANUFACTURED BY GRACO. These items sold, but not manufactured by Graco (such as electric motors, switches, hose, etc.), are subject to the warranty, if any, of their manufacturer. Graco will provide purchaser with reasonable assistance in making any claim for breach of these warranties.

In no event will Graco be liable for indirect, incidental, special or consequential damages resulting from Graco supplying equipment hereunder, or the furnishing, performance, or use of any products or other goods sold hereto, whether due to a breach of contract, breach of warranty, the negligence of Graco, or otherwise.

FOR GRACO CANADA CUSTOMERS

The Parties acknowledge that they have required that the present document, as well as all documents, notices and legal proceedings entered into, given or instituted pursuant hereto or relating directly or indirectly hereto, be drawn up in English. Les parties reconnaissent avoir convenu que la rédaction du présente document sera en Anglais, ainsi que tous documents, avis et procédures judiciaires exécutés, donnés ou intentés, à la suite de ou en rapport, directement ou indirectement, avec les procédures concernées.

Graco Information

For the latest information about Graco products, visit www.graco.com.
For patent information, see www.graco.com/patents.

To place an order, contact your Graco Distributor or call to identify the nearest distributor.
Phone: 612-623-6921 **or Toll Free:** 1-800-328-0211 **Fax:** 612-378-3505

All written and visual data contained in this document reflects the latest product information available at the time of publication.
Graco reserves the right to make changes at any time without notice.

Original Instructions. This manual contains English. MM 332989

Graco Headquarters: Minneapolis
International Offices: Belgium, China, Japan, Korea

GRACO INC. AND SUBSIDIARIES • P.O. BOX 1441 • MINNEAPOLIS MN 55440-1441 • USA
Copyright 2014, Graco Inc. is registered to ISO 9001

www.graco.com