

ProMix[®] 3KS

313881C

Plural Component Proportioner

EN

Manual and Automatic systems for proportional mixing of plural component coatings.
For professional use only.

Approved for use in explosive atmospheres (except the EasyKey and 3KS Power Supply Module).



Important Safety Instructions

Read all warnings and instructions in this manual. Save these instructions.

See page 4 for model information, including maximum working pressure. Equipment approval labels are on page 3. Some components shown are not included with all systems.

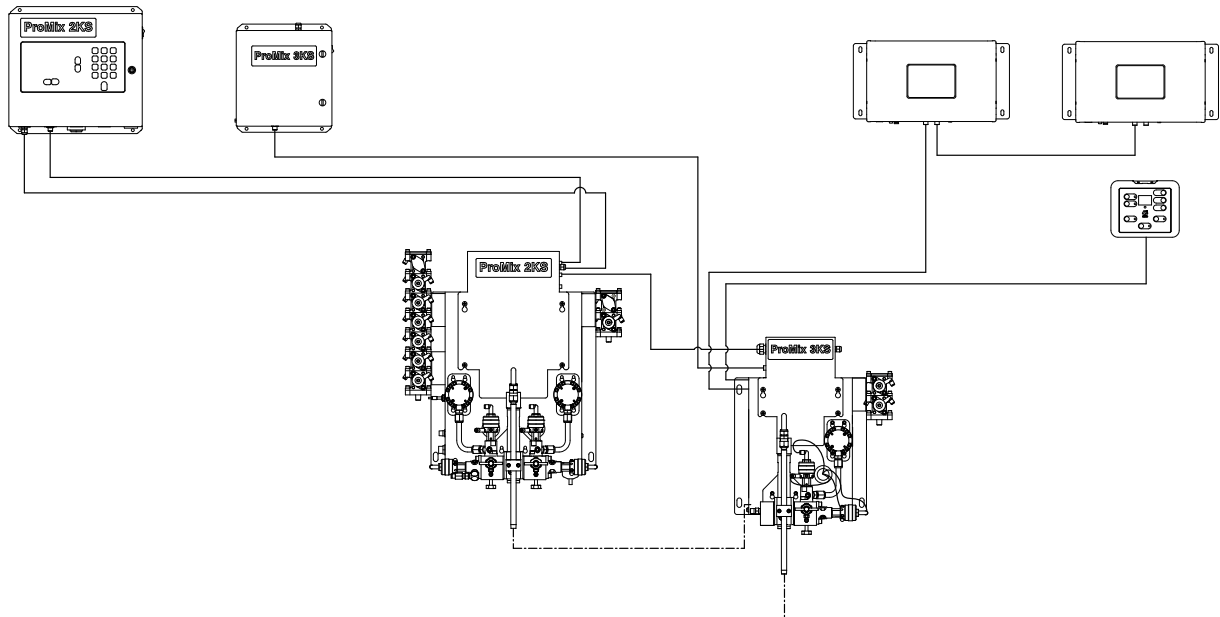

T114543a



Contents

Related Manuals	3
Equipment Approvals	3
System Configuration and Part Numbers	4
Configurator Key	4
Standard Features	5
Warnings	6
Component Identification and Definition	8
Location	11
Location Requirements	11
Intrinsically Safe Installation Requirements . . .	11
Optional Cables	11
General Information	13
Wall Mounting	13
Install the ProMix 3KS Upgrade Board	14
Air Supply	16
Requirements	16
Air Connections	17
Fluid Supply	18
Requirements	18
Fluid Connections	18
Electrical	20
Requirements	20
Connect Main Power	20
Connect Power Supply Module to ProMix 3KS Fluid Station	21
Connect Booth Control to ProMix 3KS Fluid Station 21	
Connect Color Change Module to ProMix 3KS Fluid Station	21
CAN Isolation Board Switch Setting	21
Fluid Station Control Board Switch Settings . . .	23
Connect ProMix 2KS Fluid Station to ProMix 3KS Fluid Station	24
Connect ProMix 3KS Solenoid Wiring Cable to ProMix 2KS Fluid Station Board	24
Connect Color Change Module	28
Grounding	32
Check Resistance	32
Schematic Diagrams	34
System Pneumatic Schematic	34
System Electrical Schematic	36
Dimensions and Mounting Hole Layouts	40
California Proposition 65	41
Technical Data	43
Graco Standard Warranty	44

Related Manuals

Component Manuals in English

Manual	Description
313882	ProMix 3KS Manual System Operation
313885	ProMix 3KS Automatic System Operation
313883	ProMix 3KS Repair-Parts
312775	ProMix 2KS Manual System Installation
312776	ProMix 2KS Manual System Operation
312777	ProMix 2KS Manual System Repair-Parts
312778	ProMix 2KS Automatic System Installation
312779	ProMix 2KS Automatic System Operation
312780	ProMix 2KS Automatic System Repair-Parts
312781	Fluid Mix Manifold
312782	Dispense Valve
312783	Color Change Valve Stacks
312787	Color Change Module Kit
312784	Gun Flush Box Kits
310745	Gun Air Shutoff Kit
312786	Dump Valve and Third Purge Valve Kits
312785	Network Communication Kits
308778	G3000/G3000HR Flow Meter
313599	Coriolis Flow Meter
313290	Floor Stand Kit
313542	Beacon Kit
313386	Basic Web Interface/Advanced Web Interface
406799	15V256 Automatic System Upgrade Kit
406800	15V825 Discrete I/O Board Kit

Equipment Approvals

Equipment approvals appear on the following labels which are attached to the Fluid Station and Power Supply Module. See FIG. 1 on page 4 for label locations.

Power Supply Module and Fluid Station Label

ATEX Certificate is listed here

ProMix® 3KS Electronic Proportioner

Intrinsically Safe (IS) System. Install per IS Control Drawing No. 258682. EasyKey Interface IS Associated Apparatus for use in non hazardous location, with IS Connection to Smart Fluid Plate IS Apparatus for use in: Class I, Division 1, Group D T3 C Hazardous Locations

Read Instruction Manual Warning: Substitution of components may impair intrinsic safety.

FM US APPROVED
Intrinsically safe equipment for Class I, Div 1, Group D, T3
Ta = -20°C to 50°C

CE 0359

MAX AIR WPR		
.7	7	100
MPa	bar	PSI

MAX FLUID WPR		
MPa	bar	PSI

MAX TEMP 50°C (122°F)

PART NO.	SERIES	SERIAL

MFG. YR.

--

GRACO INC.
P.O. Box 1441
Minneapolis, MN
55440 U.S.A.

T114376a

Fluid Station Label

ProMix® 3KS FLUID PANEL

PART NO.	SERIES	SERIAL	MFG. YR.

MAX AIR WPR		
.7	7	100
MPa	bar	PSI

FM US APPROVED
Intrinsically safe equipment for Class I, Div 1, Group D, T3
Ta = -20°C to 50°C
Install per 289833

CE 0359

FM08ATEX0073
II 2 G
Ex ia IIA T3

GRACO INC.
P.O. Box 1441
Minneapolis, MN
55440 U.S.A.

T114374a

ATEX Certificate is listed here

Power Supply Module Label

ProMix® 3KS POWER REQUIREMENTS

PART NO.	SERIES NO.	MFG. YR.	VOLTS
			85-250 ~
			AMPS
			2 AMPS MAX
			50/60 Hz

GRACO INC.
P.O. Box 1441
Minneapolis, MN
55440 U.S.A.

Um: 250 V

FM US APPROVED
Intrinsically safe connections for Class I, Div 1, Group D
Ta = -20°C to 50°C
Install per 258682

CE 0359

II (2) G
Ex ia IIA
FM08ATEX0072

T114375a

ATEX Certificate is listed here

System Configuration and Part Numbers

Configurator Key

The configured part number for your equipment is printed on the equipment identification labels. See FIG. 1 for location of the identification labels. The part number includes digits from each of the following categories, depending on the configuration of your system.

3K System	Component C Fluid Meter	Component C Change	Not Designated	Not Designated
TK	0 = No Meter 1 = G3000 2 = G3000HR 3 = 1/8 in. Coriolis 4 = Solvent Meter	0 = No Valves (single component C) 1 = Two Valves (low pressure) 2 = Four Valves (low pressure) 3= Two Valves (high pressure) 4= Four Valves (high pressure)	0	0

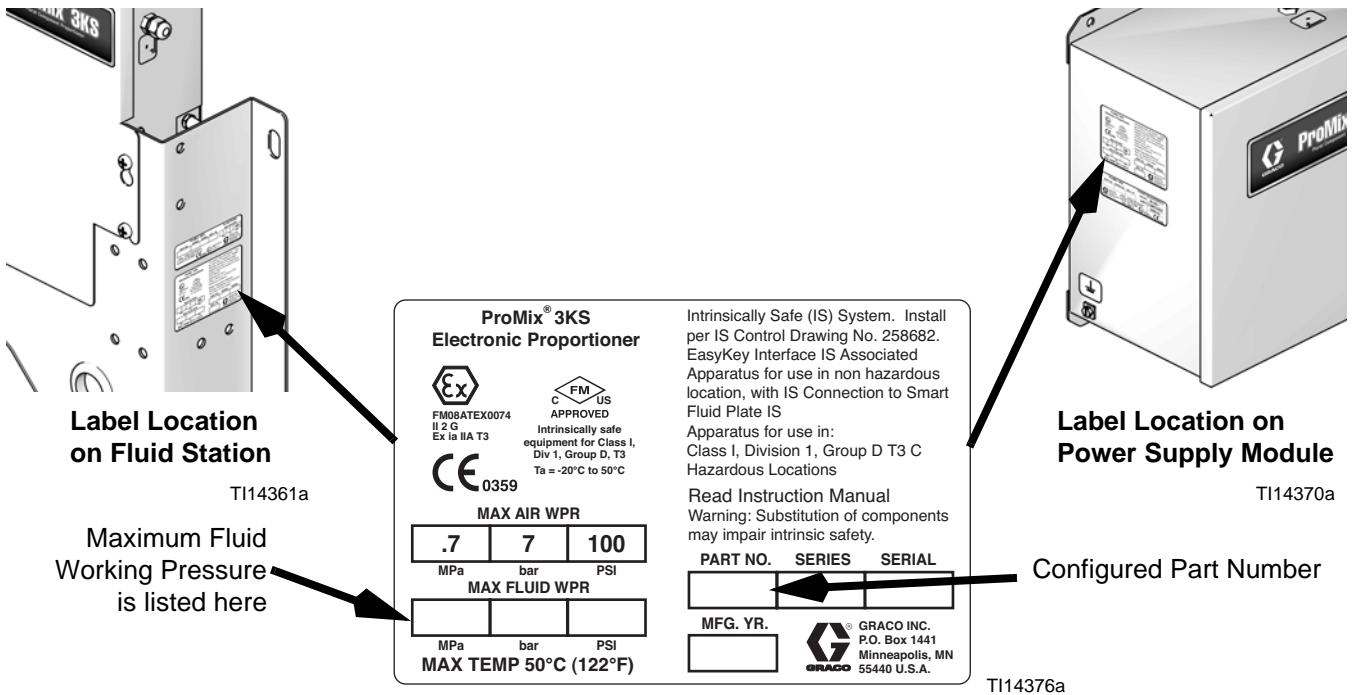

FIG. 1: Identification Label

Hazardous Location Approval

Models using a G3000, G3000HR, or intrinsically safe Coriolis meter for A, B, and C meters are approved for installation in a Hazardous Location - Class I, Div I, Group D, T3 or Zone I Group IIA T3.

Maximum Working Pressure

Maximum working pressure rating is dependent on the fluid component options selected. **The pressure rating is based on the rating of the lowest rated fluid component.** Refer to the component pressure ratings below.
Example: A Model with Flow Control has a maximum working pressure of 190 psi (1.31 MPa, 13.1 bar).

Check the identification label on the EasyKey, power supply module, or fluid station for the system maximum working pressure. See FIG. 1.

ProMix Fluid Components Maximum Working Pressure

Base System (no meters [option 0], no color/component C change [option 0], and no flow control [Optional with ProMix 2KS Base Unit])	3000 psi (21.0 MPa, 210 bar)
Meter Option 1, 2, and 4 (G3000, G3000HR, or Solvent Meter)	3000 psi (21.0 MPa, 210 bar)
Meter Option 3 (Coriolis Meter)	2300 psi (15.86 MPa, 158.6 bar)
Color Change Option 1 and 2 (low pressure valves)	300 psi (2.07 MPa, 20.6 bar)
Color Change Option 3 and 4 (high pressure valves)	3000 psi (21 MPa, 210 bar)
Flow Control (Optional with ProMix 2KS Automatic System Base Unit).	190 psi (1.31 MPa, 13.1 bar)

Flow Meter Fluid Flow Rate Range





G3000	75-3800 cc/min. (0.02-1.0 gal./min.)
G3000HR	38-1900 cc/min. (0.01-0.50 gal./min.)
Coriolis Meter	20-3800 cc/min. (0.005-1.00 gal./min.)
S3000 Solvent Meter (accessory)	38-1900 cc/min. (0.01-0.50 gal./min.)

Standard Features

Feature
ProMix 3KS Power Supply Module
Wall Mount Fluid Station, 50 cc Integrator and Static Mixer
IS Power Cable, red color coded, 50 ft (15.25 m)
CAN Communication Cable, green color coded, 10 ft (3.05 m)
Meter and Solenoid Cable, 10 ft (3.05 m)
Third Component Network Cable, yellow color coded, 6 ft (1.83 m)
C Side Dump Valve, if color valve(s) selected

Warnings

The following warnings are for the setup, use, grounding, maintenance, and repair of this equipment. The exclamation point symbol alerts you to a general warning and the hazard symbol refers to procedure-specific risk. Refer back to these warnings. Additional, product-specific warnings may be found throughout the body of this manual where applicable.

 WARNING	
	<p>FIRE AND EXPLOSION HAZARD</p> <p>Flammable fumes, such as solvent and paint fumes, in work area can ignite or explode. To help prevent fire and explosion:</p> <ul style="list-style-type: none"> • Use equipment only in well ventilated area. • Eliminate all ignition sources; such as pilot lights, cigarettes, portable electric lamps, and plastic drop cloths (potential static arc). • Keep work area free of debris, including solvent, rags and gasoline. • Do not plug or unplug power cords, or turn power or light switches on or off when flammable fumes are present. • Ground all equipment in the work area. See Grounding instructions. • Use only grounded hoses. • Hold gun firmly to side of grounded pail when triggering into pail. • If there is static sparking or you feel a shock, stop operation immediately. Do not use equipment until you identify and correct the problem. • Keep a working fire extinguisher in the work area.
	<p>ELECTRIC SHOCK HAZARD</p> <p>This equipment must be grounded. Improper grounding, setup, or usage of the system can cause electric shock.</p> <ul style="list-style-type: none"> • Turn off and disconnect power at main switch before disconnecting any cables and before servicing equipment. • Connect only to grounded power source. • All electrical wiring must be done by a qualified electrician and comply with all local codes and regulations.
	<p>INTRINSIC SAFETY</p> <p>Only models with a G3000, G250, G3000HR, G250HR, or intrinsically safe Coriolis meter for both A and B meters are approved for installation in a Hazardous Location - Class I, Div I, Group D, T3 or Zone I Group IIA T3. To help prevent fire and explosion:</p> <ul style="list-style-type: none"> • Do not install equipment approved only for a non-hazardous location in a hazardous area. See the ID label for the intrinsic safety rating of your model. • Do not substitute or modify system components as this may impair intrinsic safety.
	<p>SKIN INJECTION HAZARD</p> <p>High-pressure fluid from gun, hose leaks, or ruptured components will pierce skin. This may look like just a cut, but it is a serious injury that can result in amputation. Get immediate surgical treatment.</p> <ul style="list-style-type: none"> • Tighten all fluid connections before operating the equipment. • Do not point gun at anyone or at any part of the body. • Do not put your hand over the spray tip. • Do not stop or deflect leaks with your hand, body, glove, or rag. • Follow Pressure Relief Procedure in this manual, when you stop spraying and before cleaning, checking, or servicing equipment.

WARNING
**EQUIPMENT MISUSE HAZARD**

Misuse can cause death or serious injury.

- Do not operate the unit when fatigued or under the influence of drugs or alcohol.
- Do not exceed the maximum working pressure or temperature rating of the lowest rated system component. See **Technical Data** in all equipment manuals.
- Use fluids and solvents that are compatible with equipment wetted parts. See **Technical Data** in all equipment manuals. Read fluid and solvent manufacturer's warnings. For complete information about your material, request MSDS forms from distributor or retailer.
- Check equipment daily. Repair or replace worn or damaged parts immediately with genuine manufacturer's replacement parts only.
- Do not alter or modify equipment.
- Use equipment only for its intended purpose. Call your distributor for information.
- Route hoses and cables away from traffic areas, sharp edges, moving parts, and hot surfaces.
- Do not kink or over bend hoses or use hoses to pull equipment.
- Keep children and animals away from work area.
- Comply with all applicable safety regulations.

**TOXIC FLUID OR FUMES HAZARD**

Toxic fluids or fumes can cause serious injury or death if splashed in the eyes or on skin, inhaled, or swallowed.

- Read MSDS's to know the specific hazards of the fluids you are using.
- Store hazardous fluid in approved containers, and dispose of it according to applicable guidelines.
- Always wear impervious gloves when spraying or cleaning equipment.

**PERSONAL PROTECTIVE EQUIPMENT**

You must wear appropriate protective equipment when operating, servicing, or when in the operating area of the equipment to help protect you from serious injury, including eye injury, inhalation of toxic fumes, burns, and hearing loss. This equipment includes but is not limited to:

- Protective eyewear
- Clothing and respirator as recommended by the fluid and solvent manufacturer
- Gloves
- Hearing protection

Component Identification and Definition

See FIG. 2 and Table 1 for the system components. Components marked with a star (★) are available as part of the ProMix 3KS Kit. All other components are part of the ProMix 2KS System or are available as accessories.

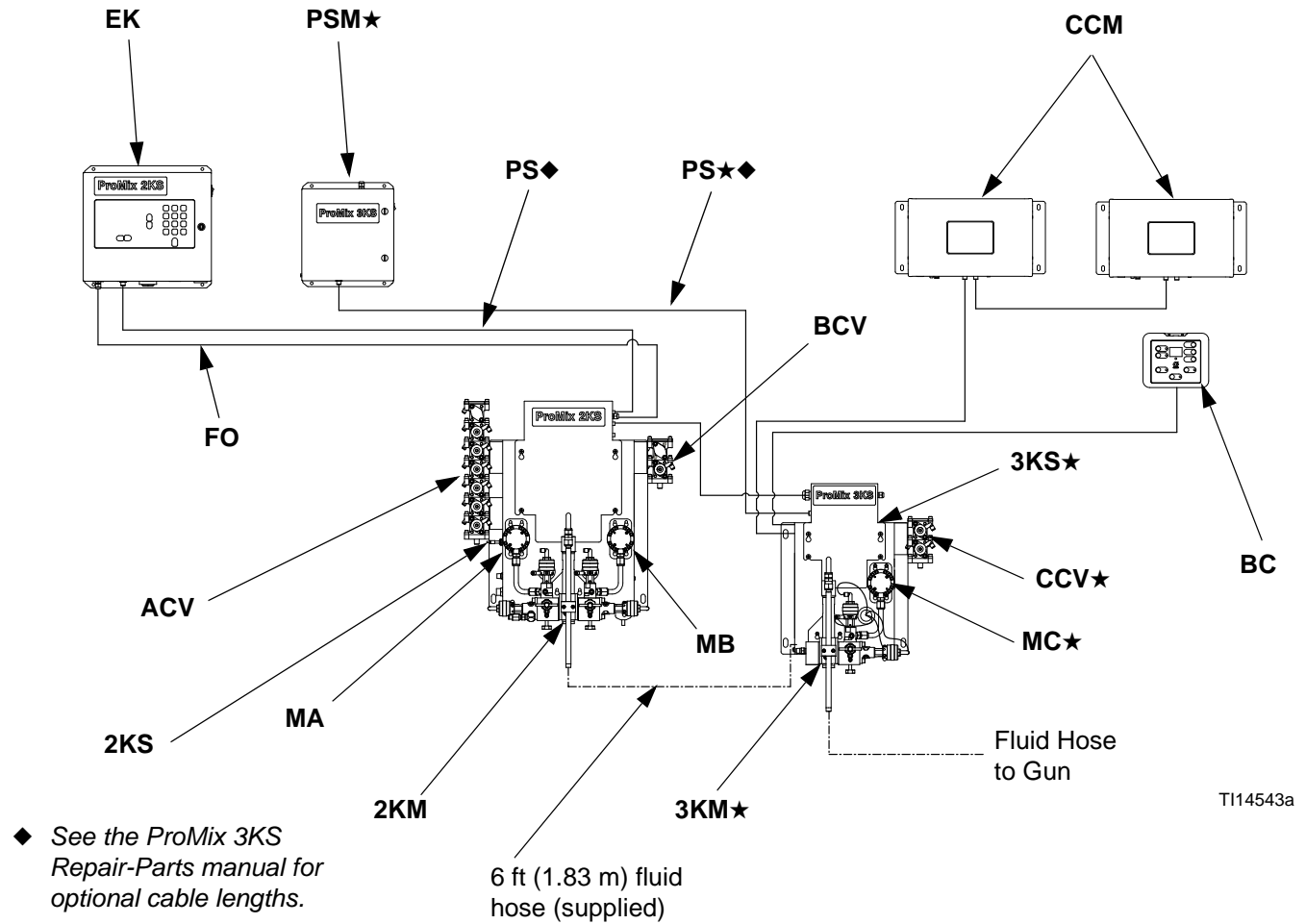

FIG. 2. Manual System Shown, with G3000 Meters, Booth Control, and Color/Catalyst/Component C Change

Table 1: Component Descriptions

Component	Description
EasyKey (EK)	Used to set up, display, operate, and monitor the system. The EasyKey accepts 85-250 VAC, 50/60 Hz line power and converts that power to acceptable low voltage and optical signals used by other system components.
★ 3KS Power Supply Module (PSM)	Accepts 85-250 VAC, 50/60 Hz line power and converts that power to acceptable low voltage signals used by other system components.
Booth Control (BC) Manual systems only	Used by the operator for daily painting functions including: choosing recipes, initiating job complete, reading/clearing alarms, and placing the system in Standby, Mix, or Purge mode. It is typically mounted inside the booth or near the painter.
2KS Fluid Station (2KS)	Includes air control solenoids, flow switches, and mountings for the component A, B, and solvent flow meters and the 2K fluid manifold assembly. Its control board manages all proportioning functions.
★ 3KS Fluid Station (3KS)	Includes air control solenoids, flow switches, and mountings for the component C and solvent flow meters and the 3K fluid manifold assembly. Its control board manages all proportioning functions.
2K Fluid Manifold (2KM)	<ul style="list-style-type: none"> • Pneumatically Operated Dose Valves for component A and B • Purge Valves for solvent and air purge • Sampling Valves for calibrating the flow meters and performing ratio checks • Shutoff Valves for component A and B to close their fluid passages to the mix manifold, to allow for accurate calibration and ratio checks • Mix Manifold, which includes the fluid integrator and static mixer. <ul style="list-style-type: none"> → Fluid Integrator is the chamber where component A and B align at the selected ratio and begin to mix. → Static Mixer has 24 elements to uniformly blend the materials downstream of the fluid integrator.
★ 3K Fluid Manifold (3KM)	<ul style="list-style-type: none"> • Pneumatically Operated Dose Valve for component C • Purge Valve for solvent • Sampling Valve for calibrating the flow meter and performing ratio check • Shutoff Valve for component C to close the fluid passage to the mix manifold, to allow for accurate calibration and ratio check • Mix Manifold, which includes the fluid integrator and static mixer. <ul style="list-style-type: none"> → Fluid Integrator is the chamber where component C aligns with blended components A/B at the selected ratio and begins to mix. → Static Mixer has 24 elements to uniformly blend the materials downstream of the fluid integrator.



Table 1: Component Descriptions

Component	Description
Flow Meters (MA, MB, ★MC, MS)	<p>Four optional flow meters are available from Graco:</p> <ul style="list-style-type: none"> • G3000 is a general purpose gear meter typically used in flow ranges of 75-3800 cc/min. (0.02–1.0 gal/min.), pressures up to 4000 psi (28 MPa, 276 bar), and viscosities of 20–3000 centipoise. The K-factor is approximately 0.119 cc/pulse. • G3000HR is a high resolution version of the G3000 meter. It is typically used in flow ranges of 38–1900 cc/min. (0.01–0.5 gal/min.), pressures up to 4000 psi (28 MPa, 276 bar). and viscosities of 20–3000 centipoise. The K-factor is approximately 0.061 cc/pulse. • S3000 is a gear meter used for solvents in flow ranges of 38-1900 cc/min. (0.01–0.50 gal/min.), pressures up to 3000 psi (21 MPa, 210 bar), and viscosities of 20–50 centipoise. The K-factor is approximately 0.021 cc/pulse. • Coriolis is a specialty meter capable of a wide range of flow rates and viscosities. This meter is available with 1/8 in. or 3/8 in. diameter fluid passages. For detailed information on the Coriolis meter, see manual 313599. The K-factor is user-settable; at lower flow rates use a lower K-factor. <ul style="list-style-type: none"> → 1/8 in. fluid passages: set K-factor to .020 or .061. → 3/8 in. fluid passages: set K-factor to .061 or 0.119.
Color Change Valves (ACV) and Color Change Module (CCM)	An optional component. It is available as a color change valve stack for either low or high pressure with up to 25 color change valves. Each stack includes one additional valve for solvent to clean the fluid line between color changes.
Catalyst Change Valves (BCV)	An optional component. It is available as a catalyst change valve stack for either low or high pressure with up to 4 catalyst change valves. Each stack includes one additional valve for solvent to clean the fluid line between catalyst changes.
★ Component C Change Valves (CCV)	An optional component. It is available as a component C change valve stack for either low or high pressure with up to 4 component C change valves. Each stack includes one additional valve for solvent to clean the fluid line between component C changes.
Dual Fiber Optic Cable (FO)	Used to communicate between the EasyKey and Wall Mount Fluid Station.
★ Fluid Station Power Supply Cable (PS)	Used to provide power to the Wall Mount Fluid Station.
Flow Control Regulator Assembly (FC) Automatic systems only	Not shown. See ProMix 2KS manuals for details.
Applicator Handling: use Air Flow Switch (AFS) or Gun Flush Box (GFB)	Not shown. See ProMix 2KS manuals for details.

Location

NOTE: To install the ProMix 2KS, see Installation Manual 312775 (manual systems) or 312778 (automatic systems).

Location Requirements

						
<p>Do not substitute or modify system components as this may impair intrinsic safety. For installation, maintenance or operation instructions, read instruction manuals. Do not install equipment approved only for non-hazardous location in a hazardous area. See the identification label (FIG. 1) on the EasyKey, power supply module, or fluid station for the intrinsic safety rating for your model.</p>						

NOTE: Mount 3KS Power Supply Module and 3KS Fluid Station within 50 ft (15.2 m) of each other, using PN 123271 cable (red color coded).

NOTE: An optional PN 123272 100 ft (30.5 m) cable is also available.

3KS Power Supply Module: Install in the non-hazardous area at a convenient location.

3KS Fluid Station: Install according to requirements for Intrinsically Safe Installation (FIG. 3) and at a convenient location to connect to paint and solvent supplies. The fluid hose (supplied) to connect the 2KS fluid station to the 3KS fluid station is 6 ft (1.83 m) long.

NOTE: For an Intrinsically Safe Installation, the Fluid Station may be located inside or outside the hazardous location. Install according to appropriate electrical codes.

Intrinsically Safe Installation Requirements

See FIG. 3 on page 12.

1. The non-intrinsically safe terminals (power rail) must not be connected to any device which uses or generates more than 250 Vrms or dc unless it has been determined that the voltage has been adequately isolated.
2. The installation must meet the requirements of the National Electric Code, Canadian Electrical Code Part I, NFPA 70, Article 504 Resp., Article 505 and ANSI/ISA 12.06.01.
3. Multiple earthing of components is allowed only if high integrity equipotential system is realized between the points of bonding.
4. Do not operate system with safety barrier cover removed.
5. For ATEX, install per EN 60079-14 and applicable local and national codes.
6. Install Coriolis flow meters as explosion proof (USA, Canada)/flameproof Ex d (ATEX) with passive intrinsically safe connections per the manufacturer's installation instructions and applicable codes.
7. Terminals 24 and 25 of optional Endress+Hauser Coriolis flow meters installed using intrinsically safe wiring methods. For the United States and Canada, install all other wiring for Coriolis flow meters using explosion proof wiring methods for Division I. For ATEX installations, install all other wiring for Coriolis flow meters using Flameproof, Ex d, wiring methods for Zone 1. Observe manufacturer's instructions for installation and use.
8. For ATEX installations, interconnecting cabling specified is Type A cable in accordance with EN 60079-14.

Optional Cables

Optional CAN cables and fiber optic cables are available from Graco. See the ProMix 3KS Repair-Parts manual for available part numbers and lengths.

**FM08ATEX0074
SYSTEM ASSEMBLY CERTIFICATE**

HAZARDOUS (CLASSIFIED) LOCATION

CLASS I, DIV I, GROUP D, T3 (US AND CANADA)
CLASS I, ZONE I, GROUP IIA, T3 (ATEX ONLY)
TAUB = -20°C TO 50°C

NON-HAZARDOUS LOCATION ONLY

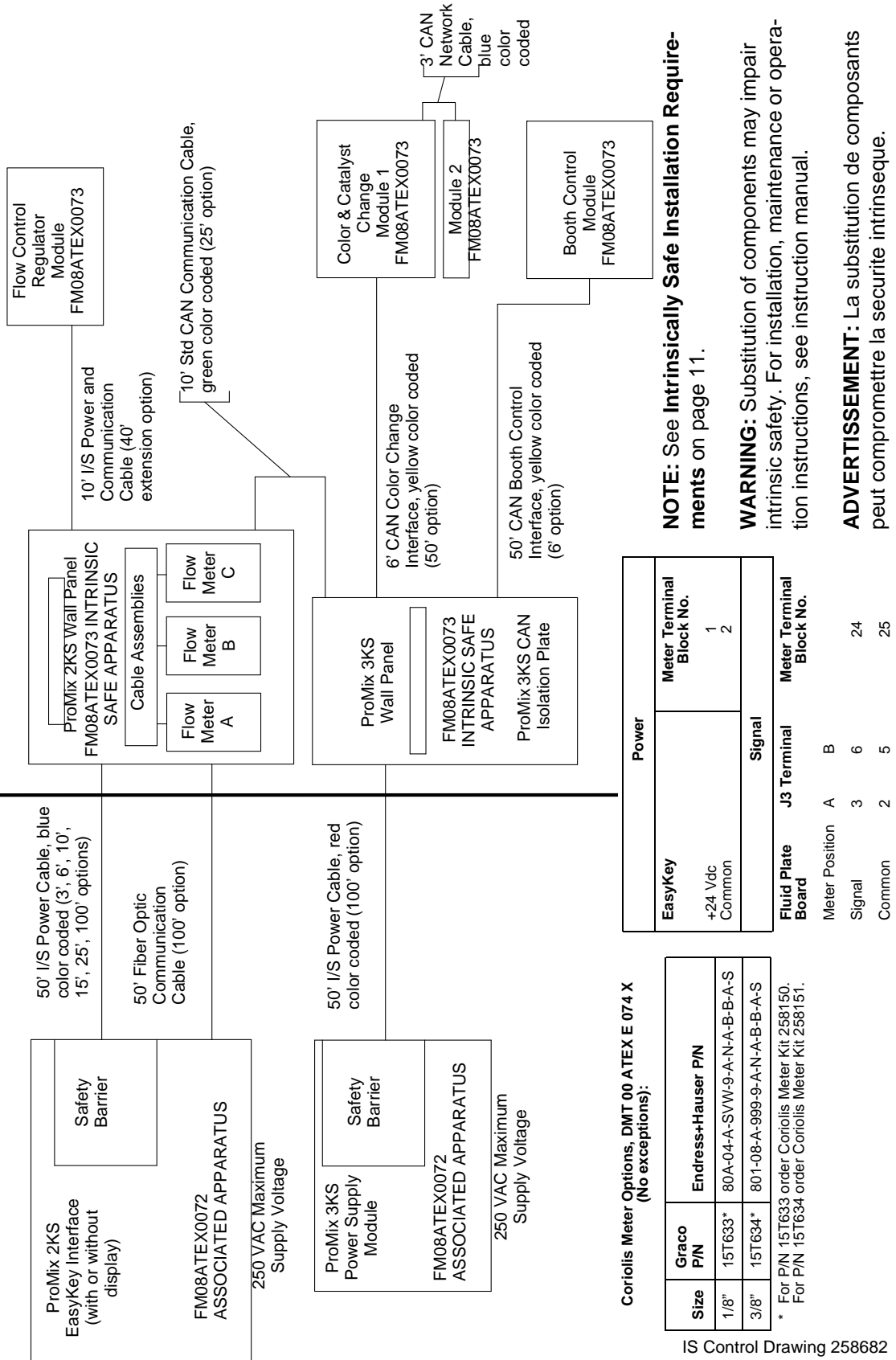

NOTE: See Intrinsically Safe Installation Requirements on page 11.

WARNING: Substitution of components may impair intrinsic safety. For installation, maintenance or operation instructions, see instruction manual.

ADVERTISSEMENT: La substitution de composants peut compromettre la sécurité intrinsèque.

Coriolis Meter Options, DMT 00 ATEX E 074 X
(No exceptions):

Size	Graco P/N	Endress+Hauser P/N
1/8"	15T633*	80A-04-A-SVW-9-A-N-A-B-A-S
3/8"	15T634*	801-08-A-999-9-A-N-A-B-B-A-S

* For P/N 15T633 order Coriolis Meter Kit 258150.
For P/N 15T634 order Coriolis Meter Kit 258151.

Power		Signal	
EasyKey	Meter Terminal Block No.	Fluid Plate Board	J3 Terminal
+24 Vdc Common	1	A	B
	2	3	6
		Common	2 5

Fig. 3. Intrinsically Safe Installation



General Information

- Reference numbers and letters in parentheses in the text refer to numbers and letters in the illustrations.
- FIG. 2, page 8, shows the basic components of a ProMix 3KS system. Contact your Graco distributor for actual system designs.
- Be sure all accessories are adequately sized and pressure-rated to meet system requirements.
- There must be a shutoff valve between the component C fluid supply line and the ProMix system.
- A 100 mesh minimum fluid filter must be installed on the component C fluid supply line.

Wall Mounting

1. See **Dimensions and Mounting Hole Layouts**, page 40.
2. Ensure that the wall and mounting hardware are strong enough to support the weight of the equipment, fluid, hoses, and stress caused during operation.
3. Using the equipment as a template, mark the mounting holes on the wall at a convenient height for the operator and so equipment is easily accessible for maintenance.
4. Drill mounting holes in the wall. Install anchors as needed.
5. Bolt equipment securely.

Install the ProMix 3KS Upgrade Board

						
<ul style="list-style-type: none">• To avoid electric shock, turn off EasyKey power before servicing.• Servicing EasyKey exposes you to high voltage. Shut off power at main circuit breaker before opening enclosure.• All electrical wiring must be done by a qualified electrician and comply with all local codes and regulations.• Do not substitute or modify system components as this may impair intrinsic safety.• Read Warnings, page 6.						

NOTICE
To avoid damaging circuit board when servicing, wear grounding strap on wrist and ground appropriately.

1. Shut off ProMix 2KS power (0 position). FIG. 4. Also shut off power at main circuit breaker.

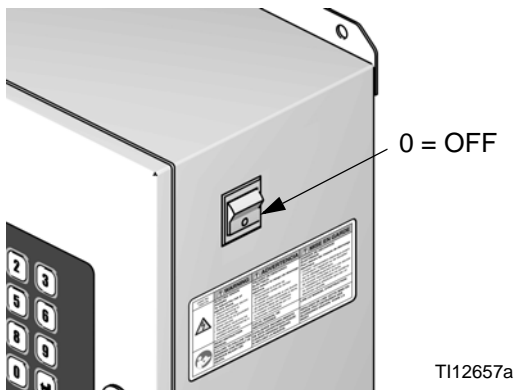
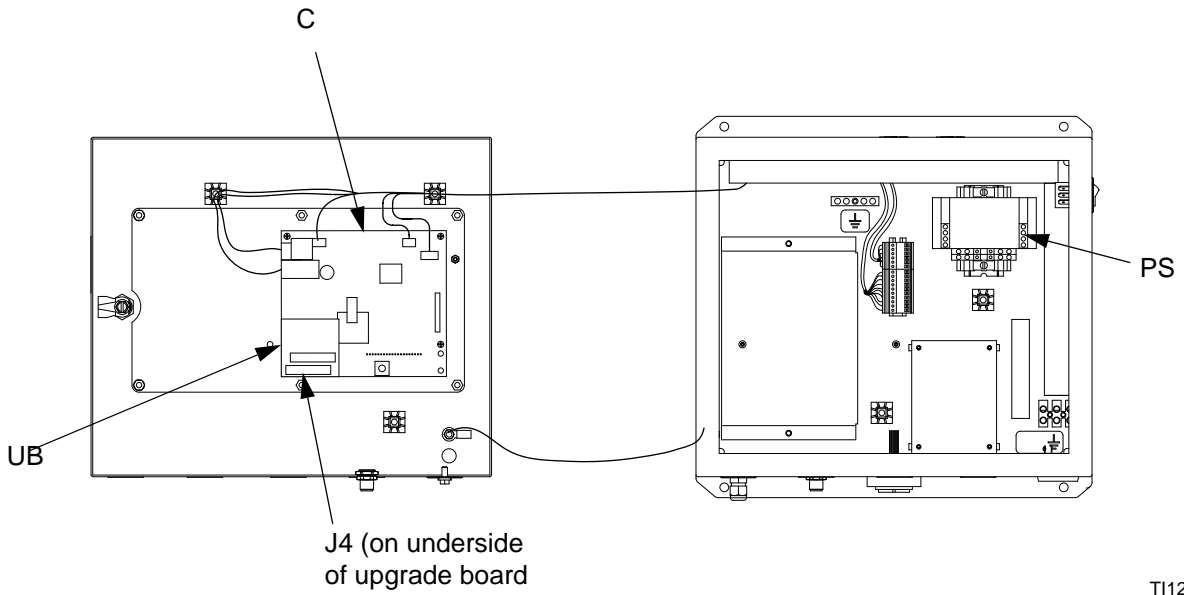

FIG. 4: Power Off

2. Unlock and open EasyKey door with its key.
3. Locate the display board (C). FIG. 5.
4. Remove one screw (E) and unplug the existing ProMix 2KS auto key board from the display board assembly. FIG. 5.

NOTE: Manual systems may not have an auto key board. Go to step 5.

5. Align connector J4 on the underside of the new ProMix 3KS upgrade board (UB) with J3 on the display board. Press them together. FIG. 5.
6. Secure the ProMix 3KS upgrade board (UB) with the screw (E).



TI12496a

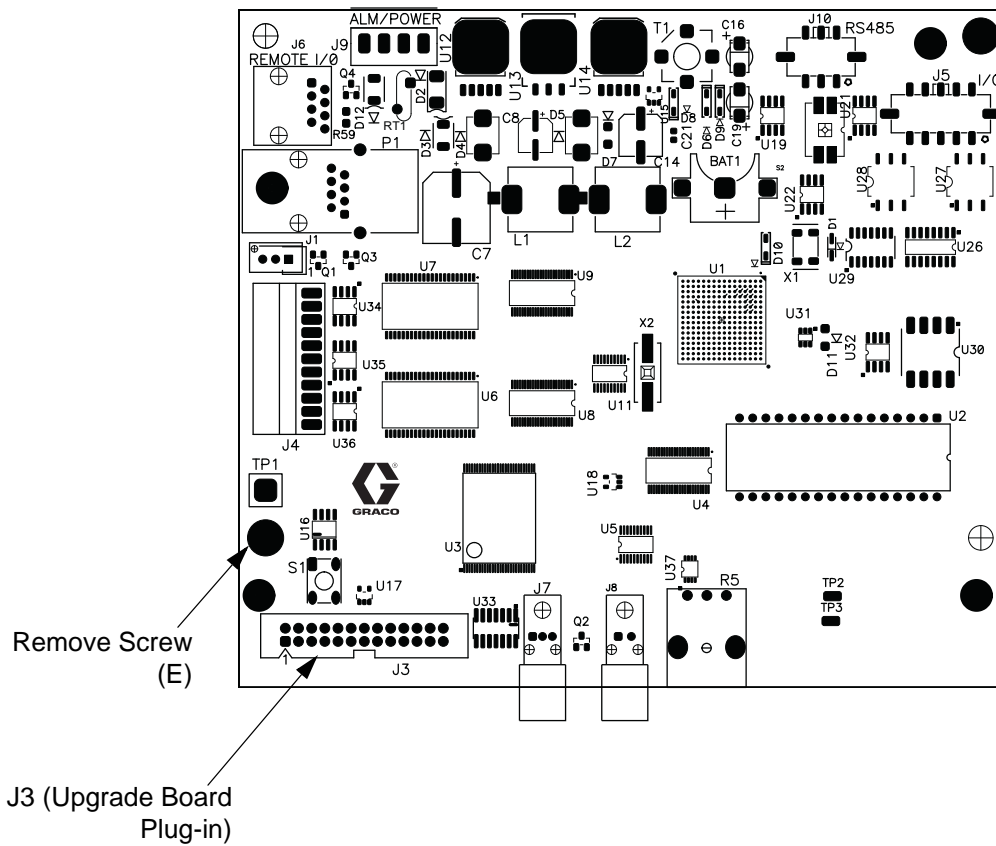





FIG. 5: 255767 Display Board Connectors

Air Supply

Requirements

- **Compressed air supply pressure:** 75-100 psi (517-700 kPa, 5.2-7 bar).
- **Air hoses:** use grounded hoses that are correctly sized for your system.

						
<p>Trapped air can cause a pump or dispense valve to cycle unexpectedly, which could result in serious injury from splashing or moving parts. Use bleed-type shutoff valves.</p>						

- **Air regulator and bleed-type shutoff valve:** include in each air line to fluid supply equipment. Install an additional shutoff valve upstream of all air line accessories to isolate them for servicing.
- **Air line filter:** a 10 micron or better air filter is recommended to filter oil and water out of the air supply and help avoid paint contamination and clogged solenoids. See FIG. 2.

Air Connections

See the **System Pneumatic Schematic** on page 34.

1. Tighten all ProMix system air and fluid line connections as they may have loosened during shipment.
2. Install a bleed-type air shutoff valve into the control air filter inlet on the 2KS Wall Mount Fluid Station. See FIG. 6.
3. Connect a 1/4 in. (6 mm) OD air supply line between the 2KS air manifold and the 3KS air inlet elbow.

NOTICE

Use separate air supply lines for the following two connections to avoid contaminating the purge air line with fluid if the air purge valve and a check valve failed.



4. Connect a clean air supply line to the shutoff valve. This air line supplies air to operate the gun, solenoids, and dispense valves.

NOTE: See **Technical Data** on page 43 for additional air supply/consumption information.

5. Install a bleed-type shutoff valve into the air purge valve inlet on the 2KS Wall Mount Fluid Station.
6. Connect the air purge valve tubing (supplied) to a clean, dry air supply (install filters/dryers as needed).

NOTICE

The ProMix potlife timer will not function properly when used with multiple guns operating simultaneously. To avoid having mixed material set in the equipment, carefully monitor potlife by some other means.

					
<p>If using a Graco electrostatic PRO™ Gun, a shutoff valve must be installed in the gun air line to shutoff the atomizing and turbine air to the gun. Contact your Graco distributor for information on air shutoff valves for electrostatic applications.</p>					

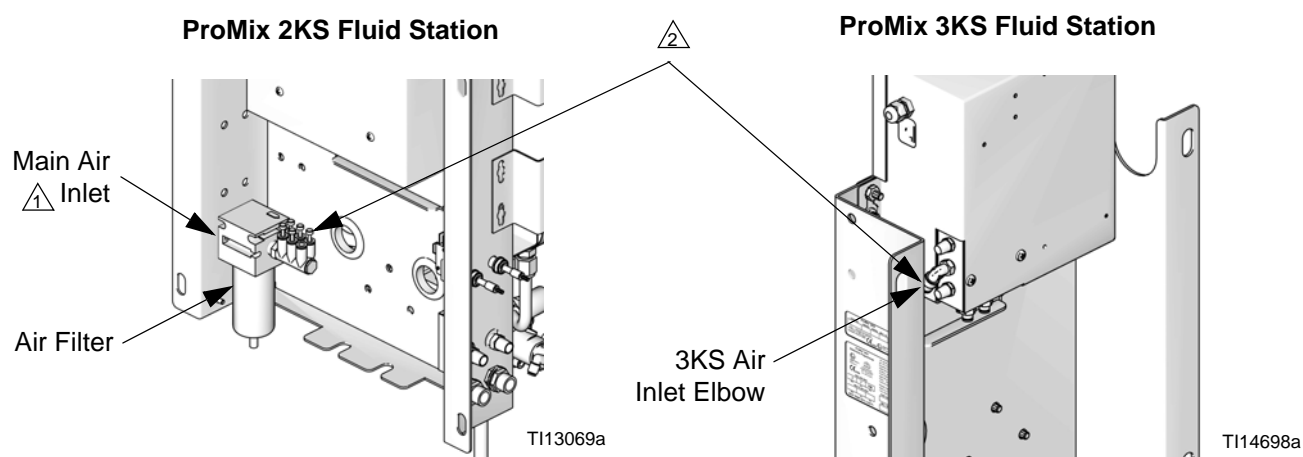

 Install a bleed-type air shutoff valve here.









 Connect 1/4 in. (6 mm) OD, 10 ft (3 m) air line between 2KS manifold and 3KS air inlet elbow.

FIG. 6. Connect Air from ProMix 2KS Fluid Station to ProMix 3KS Fluid Station

Fluid Supply

Requirements

						
Do not exceed the pressure rating of the lowest rated component. See the identification label (FIG. 1 on page 4).						

						
To reduce the risk of injury, including fluid injection, you must install a shutoff valve between each fluid supply line and the fluid manifold assembly. Use the valves to shut off fluid during maintenance and service.						

ProMix models are available to operate air spray or air-assisted systems with a capacity of up to 3800 cc/min.

- Fluid supply pressure tanks, feed pumps, or circulating systems can be used.
- Materials can be transferred from their original containers or from a central paint recirculating line.
- For an airless system, the user must supply a gun trigger signal to the ProMix 3KS.
- See manual 313599 for Coriolis meter installation and operation instructions.

NOTE: The fluid supply must be free of pressure spikes, which are commonly caused by pump stroke change-over. If necessary, install pressure regulators or a surge tank on the ProMix fluid inlets to reduce pulsation. Contact your Graco distributor for additional information.

Fluid Connections

1. Connect the solvent supply lines.
 - a. Connect the solvent supply line to the 1/4 npt(f) solvent purge valve inlet. See FIG. 7.
 - b. **Multiple color system:** also connect a solvent supply line to the color change stack (Q), top valve 4 or 5. See FIG. 8.

NOTE: Solvent supplied by a single source can cause cross contamination and damage to the system. Install check valves or use separate solvent sources.

2. Connect the component C supply line(s).
 - **Single component C system:** connect component supply line to the component C flow meter inlet.
 - **Multiple component C system:** connect component C supply lines to the color change valve stack (S) inlets. See FIG. 8. The color number is marked on the valve air supply line.

NOTE: Paint Recirculating System Only

- The color change valves have two fluid ports for each individual valve. If you are recirculating paint, plumb the valves in one port and out the other.
- Another option is to use a tee fitting to recirculate.

NOTICE
Verify that all unused fluid ports on the color change valve stack are plugged before operation. An open port will leak fluid.

3. Connect the 6 ft (1.83 m) fluid line (supplied) from the 2KS fluid manifold static mixer outlet to the 3KS fluid manifold inlet. See FIG. 7.

NOTE: The fluid meter inlets have fluid check valves to prevent backflow from fluid supply pressure fluctuations. Backflow can cause ratio inaccuracies.

4. Connect the gun fluid supply line between the 3KS fluid manifold static mixer outlet and the gun fluid inlet.

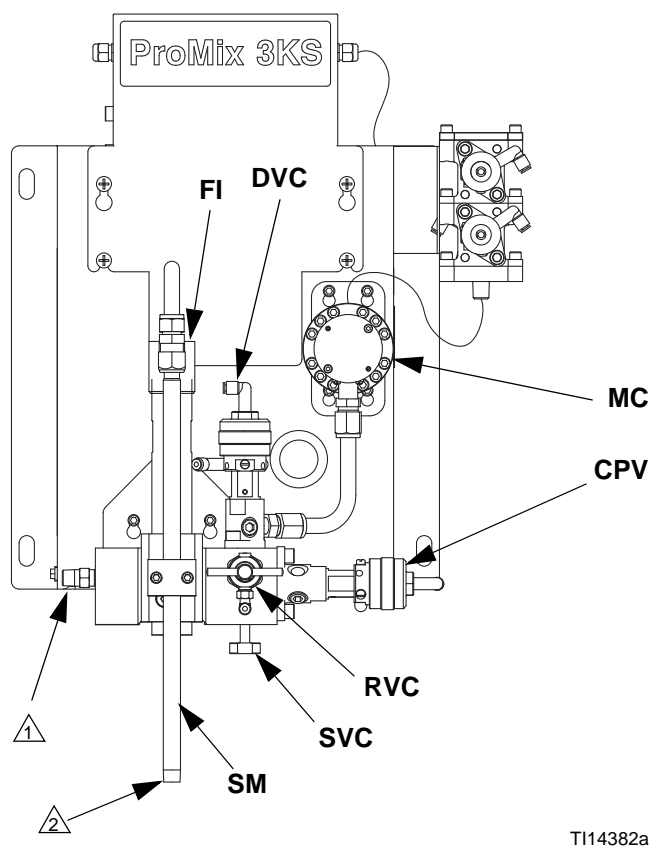

T114382a

FIG. 7. Wall Mount Fluid Station, Sequential Dosing

Key:

- MC Component C Meter
- DVC Component C Dose Valve
- RVC Component C Sampling Valve
- SVC Component C Shutoff Valve
- CPV Component C Purge Valve
- SM Static Mixer
- FI Fluid Integrator

- 1 3KS fluid inlet. Connect 6 ft (1.83 m) fluid supply line from 2KS fluid manifold static mixer outlet to 1/4 npt(m) fitting.
- 2 Connect gun fluid supply line to 1/4 npt fluid outlet.

Color Change Board and Solenoid Valves

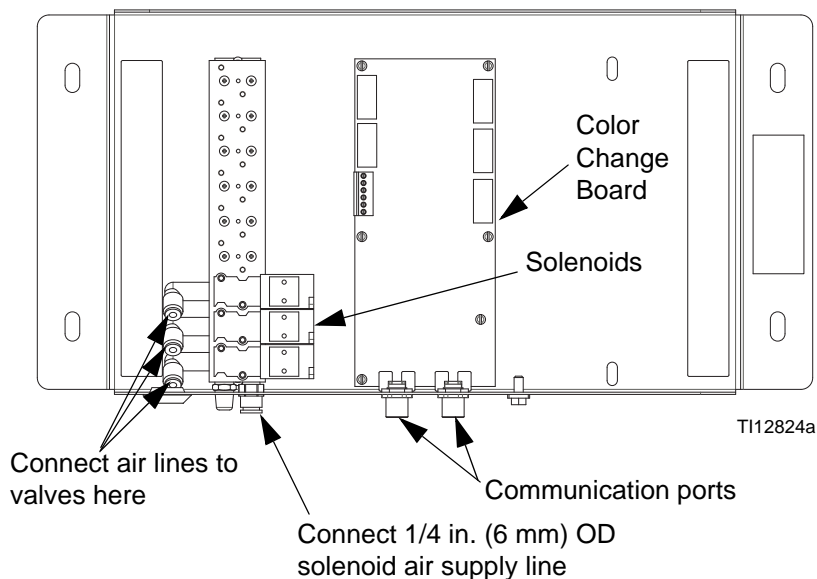

T112824a

Color Change Valve Stack

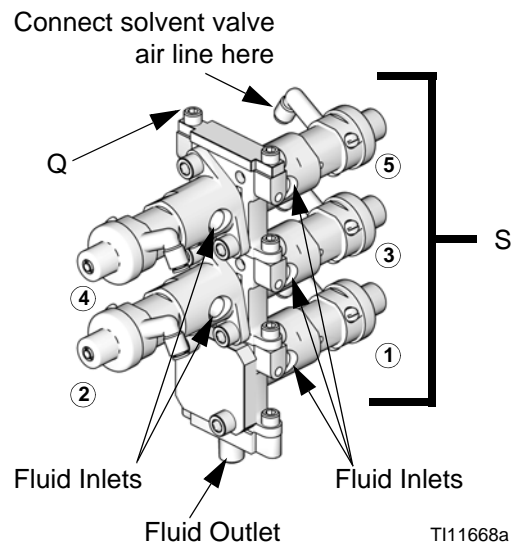



T111668a

FIG. 8. Color Change Valves Air and Fluid Connections

Electrical

Requirements

						
---	---	---	--	--	--	--

- To avoid electric shock, turn off EasyKey power before servicing.
- Servicing EasyKey exposes you to high voltage. Shut off power at main circuit breaker before opening enclosure.
- All electrical wiring must be completed by a qualified electrician and comply with all local codes and regulations.
- Enclose all cables routed in the spray booth and high traffic areas in conduit to prevent damage from paint, solvent, and traffic.

NOTE: All options ordered on the ProMix system are electrically tested at the factory.

The ProMix operates with 85-250 VAC, 50/60 Hz input power, with a maximum of 2 amp current draw. The power supply circuit must be protected with a 15 amp maximum circuit breaker.

Not included with system:

- Power supply cord compatible to your local power configuration. Wire gauge size must be 8-14 AWG.
- The input power access port  is 22.4 mm (0.88 in.) diameter. It accepts a bulkhead strain relief fitting or conduit. See FIG. 10.

Connect Main Power

1. Provide power to the Power Supply Module. Install a bulkhead strain relief or conduit bulkhead through the Power Supply Module port . See FIG. 10.
2. See FIG. 9 and the **System Electrical Schematic** on page 36 for the L1, N, and ground wiring connections inside the Power Supply Module.
3. Ground the Power Supply Module to a true earth ground. See **Grounding**, page 32.

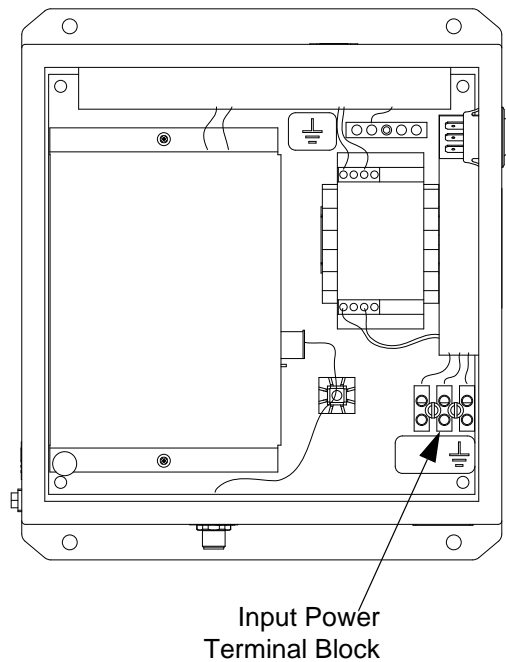

T114368a

FIG. 9. Main Power Connection

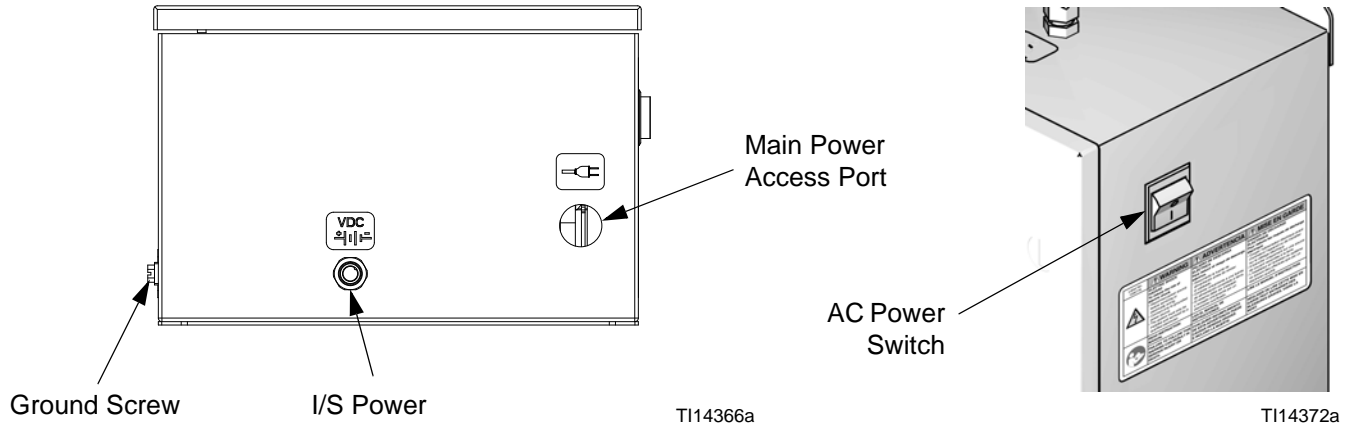



FIG. 10. Power Supply Module Connections and AC Power Switch

Connect Power Supply Module to ProMix 3KS Fluid Station

1. Connect one end of the 50 ft (15.2 m) Fluid Station Power Cable (Part No. 123271, red color coded) to the Power Supply Module I/S Power connector $\overset{\text{VDC}}{\pm}| | \text{—}$. See FIG. 10.
2. Connect the other cable end to the ProMix 3KS Fluid Station Control connector $\overset{\text{VDC}}{\pm}| | \text{—}$ (J3). See FIG. 13 and FIG. 15.

Connect Booth Control to ProMix 3KS Fluid Station

NOTE: The booth control is supplied with ProMix 2KS manual systems. Disconnect and discard the 50 ft (15.2 m) gray cable connecting the booth control to the ProMix 2KS fluid station.

Connect the 50 ft (15.2 m) Booth Control Cable (Part No. 123280, yellow color coded) from the Booth Control to the ProMix 3KS Fluid Station connector  (J1). See FIG. 13 and FIG. 15.

Connect Color Change Module to ProMix 3KS Fluid Station

NOTE: Disconnect and discard the 3 ft (0.9 m) gray cable (supplied with the ProMix 2KS system) connecting the color change module to the ProMix 2KS fluid station.

Connect the 6 ft (1.83 m) Color Change Cable (Part No. 123277, yellow color coded) from the Color Change Module to the ProMix 3KS Fluid Station connector  (J2). See FIG. 13 and FIG. 15.

NOTE: If you are using two color change modules to add component C change, connect a 5-pin electrical cable from the first color change board to the second color change board. See FIG. 3 and FIG. 17.

CAN Isolation Board Switch Setting

Set switch S1 on CAN isolation board if color change module and/or booth control are connected. See FIG. 11 and Table 2 on page 22.

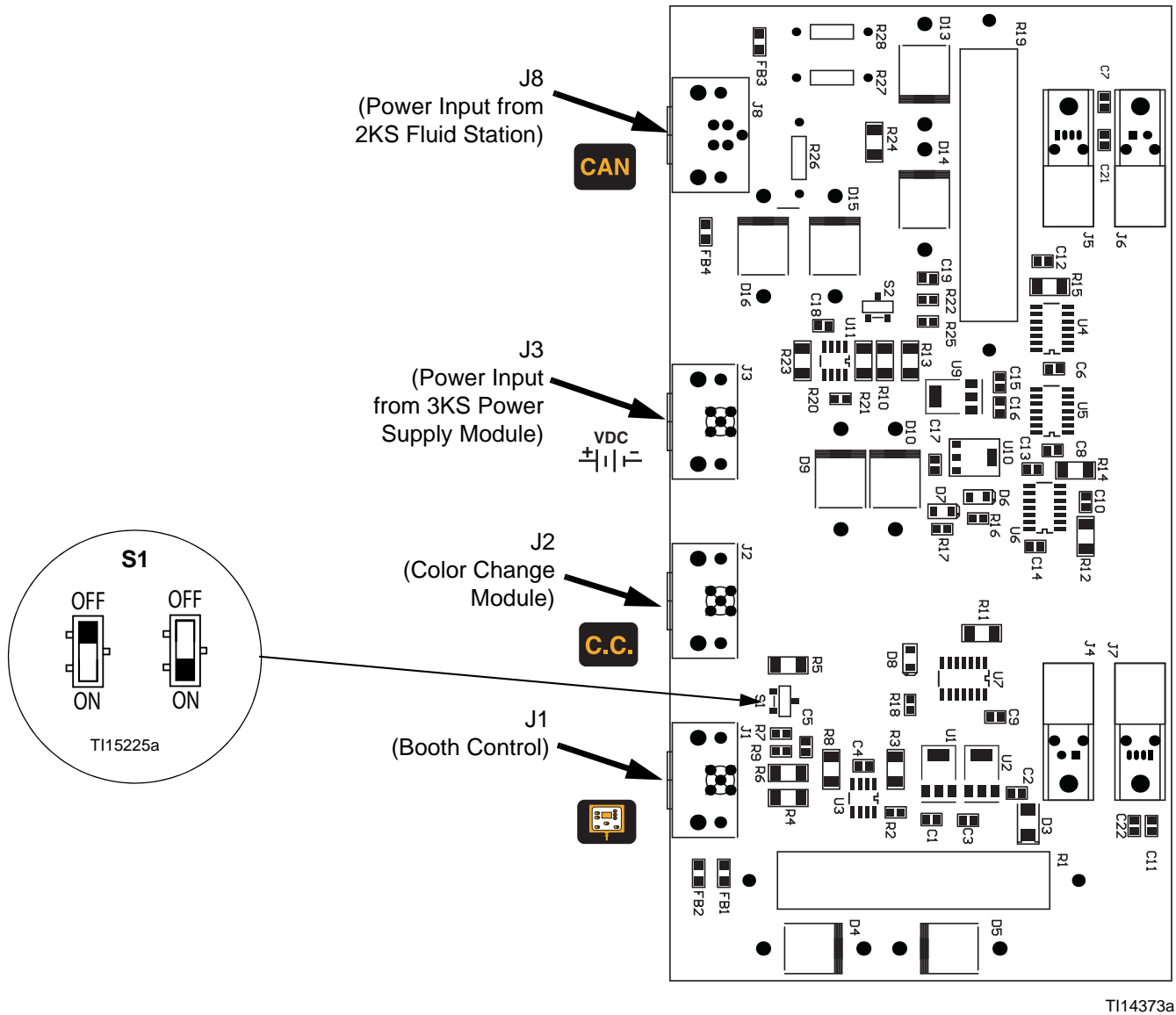

T114373a

FIG. 11. ProMix 3KS CAN Isolation Board

Table 2: 3KS CAN Isolation Board Switch Settings

Component	Connector	Diagnosis
S1	J1, J2	<p>If booth control is connected to J1 and color change module is connected to J2, set switch S1 to OFF.</p> <p>If booth control is connected to J1 or color change module is connected to J2, set switch S1 to ON.</p> <p>If booth control is not connected to J1 and color change module is not connected to J2, set switch S1 to ON.</p>

Fluid Station Control Board Switch Settings

See FIG. 12. On the 2KS fluid station control board, set switch S1 to ON (down) for all ProMix 3KS units.

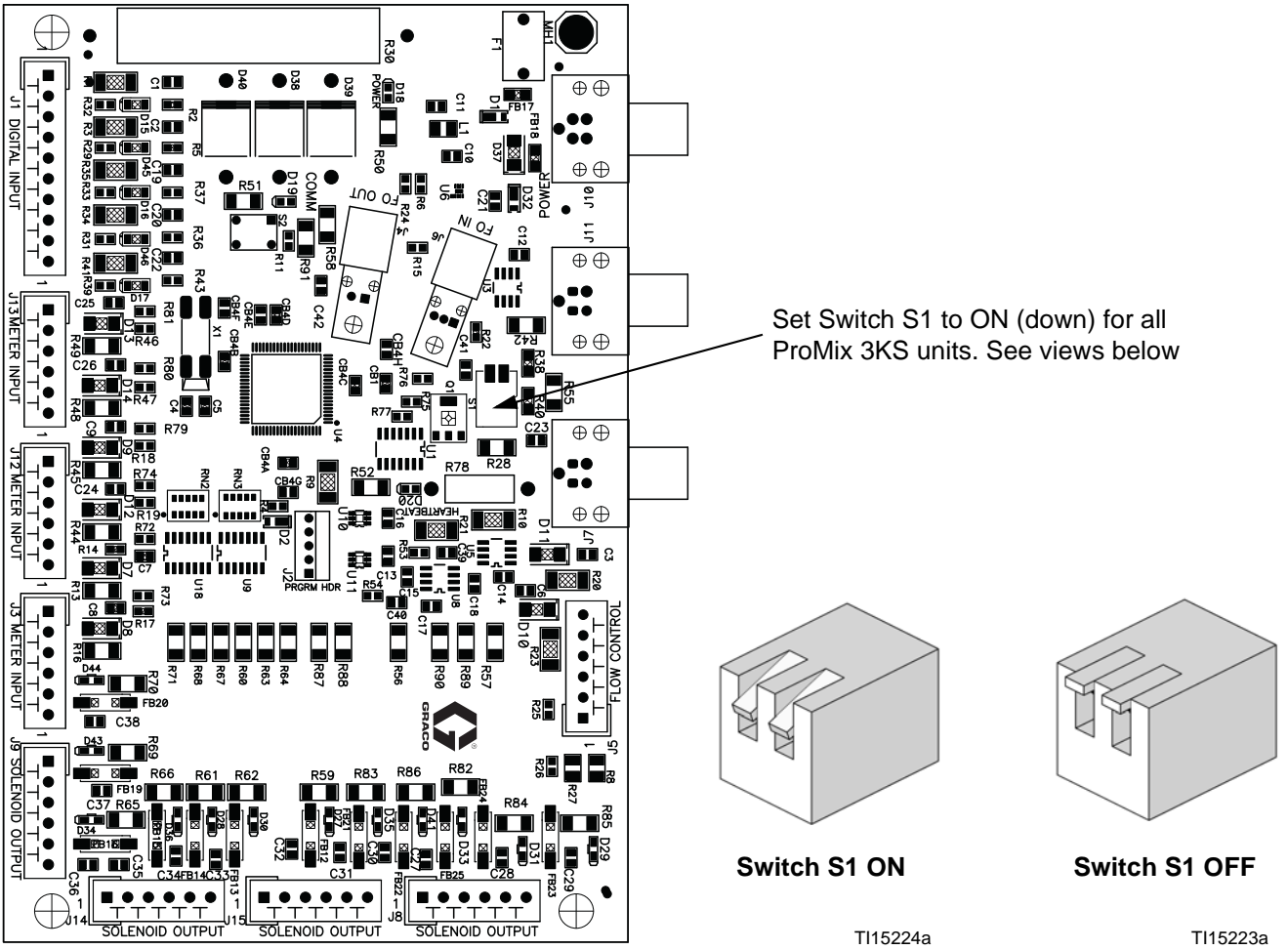

FIG. 12: 255765 Fluid Station Control Board

Connect ProMix 2KS Fluid Station to ProMix 3KS Fluid Station

See FIG. 14. At the ProMix 2KS Fluid Station, remove the knockout and install the solenoid cable strain relief (supplied). Apply the **3KS** and **CAN** (supplied) in the locations shown.

Connect the 10 ft (3 m) Communication Cable (Part No. 123273, green color coded) from the ProMix 2KS Fluid Station to the ProMix 3KS Fluid Station connector

CAN (J8). See FIG. 13, FIG. 14, and FIG. 15.

Connect ProMix 3KS Solenoid Wiring Cable to ProMix 2KS Fluid Station Board

See FIG. 14 and FIG. 15. The solenoid wiring cable is shipped attached to the ProMix 3KS Fluid Station. Connect the cable to the ProMix 2KS Fluid Station Board by threading it through the strain relief port labeled **3KS**.

Connect the wires to the 2KS board as shown in Table 3 on page 26. Also refer to the **System Electrical Schematic** on pages 38 and 39.

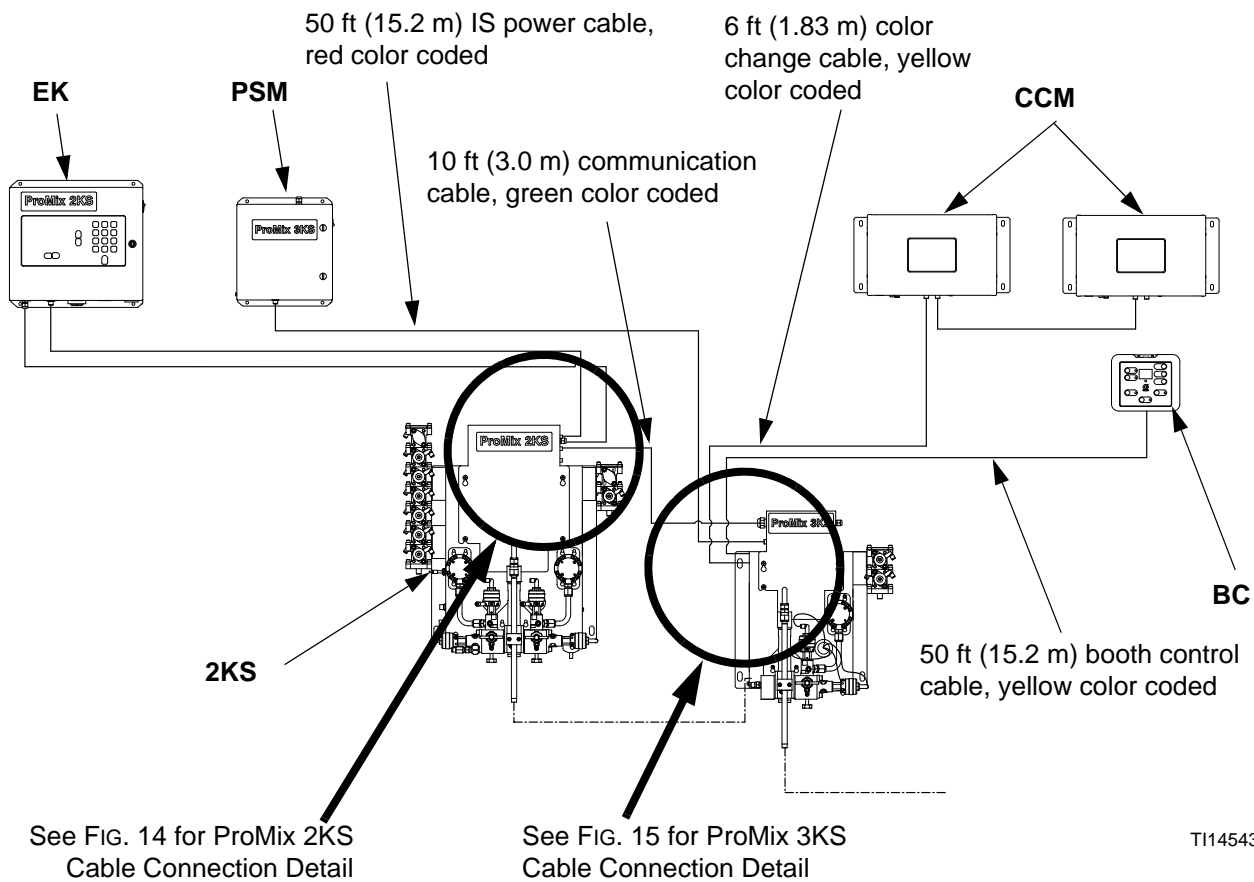

FIG. 13. ProMix 3KS Cabling Diagram

Detail of ProMix 2KS Cable Connections to ProMix 3KS

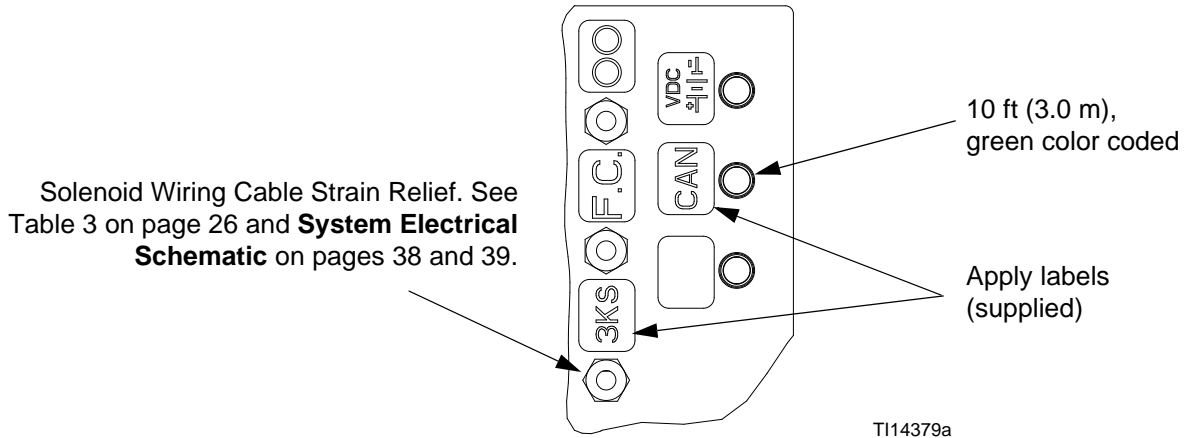
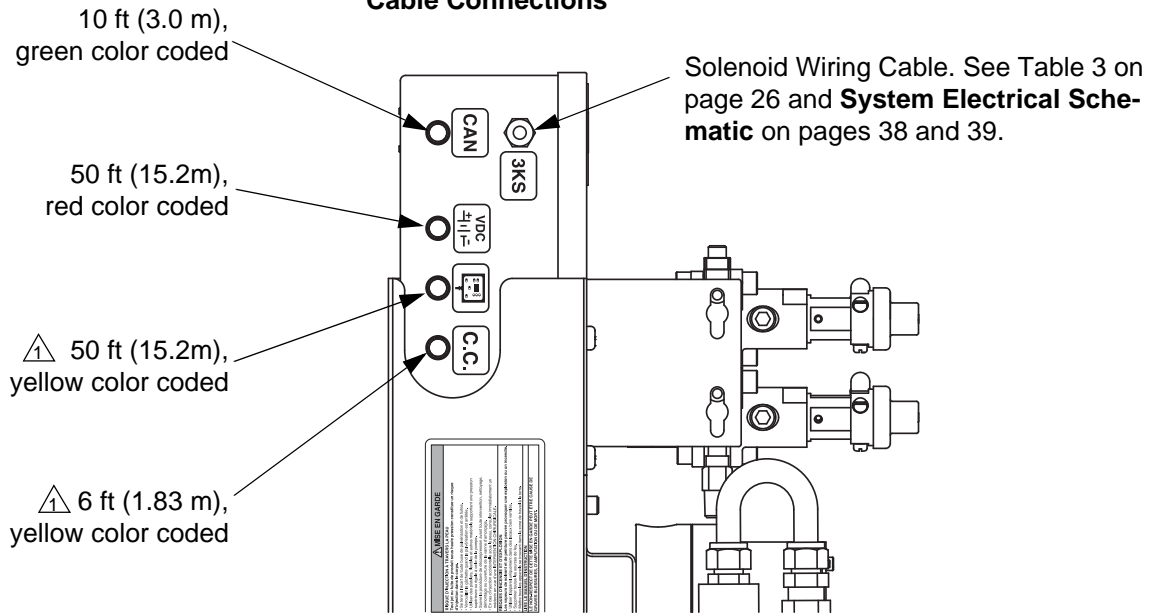

FIG. 14. ProMix 2KS Cabling Connection Detail

Detail of ProMix 3KS Cable Connections



⚠ Set switch S1 on CAN isolation board if color change module and/or booth control are connected. See FIG. 11 and Table 2 on page 22.

FIG. 15. ProMix 3KS Cabling Connection Detail

Table 3: Solenoid Wiring Cable Connections

ProMix 3KS End		Description	ProMix 2KS End (Board 255765)	
Wire Color	Terminal Block Pin No.		Wire Color	Pin No.
Red	1	Meter C Power	Red	J12, 4
Black	2	Meter C Common	Black	J12, 5
White	3	Meter C Signal	White	J12, 6
Black	4	Not Used		
Black	5	Dose C -	Black	J9, 6
Green	6	Dose C +	Green	J9, 5
Black	7	Purge C -	Black	J15, 4
Blue	8	Purge C +	Blue	J15, 3
Black	9	Dump C -	Black	J14, 2
Yellow	10	Dump C +	Yellow	J14, 1

Connect Color Change Module

To install the color change module(s), see manual 312787.

Connect a 5-pin electrical cable from the labeled connection port **C.C.** (J2) on the 3KS fluid station control board to the color change board. See FIG. 16.

If you are using two color change modules to add colors, connect a 5-pin electrical cable from the first color change board to the second color change board.

Set switches S3-S6 on the color change board(s) as shown in Table 4 and FIG. 16, depending on the number of color change boards and color change modules being used in your system.

For wiring between the color change board and the solenoids, see the color change module electrical schematic, FIG. 17.

Table 4: Color Change Board Switch Settings

Two Color Change Boards								
Color Change Board 1				Color Change Board 2				Effect on System
S3	S6	S5	S4	S3	S6	S5	S4	
Termination Resistor	Board ID	Catalyst On/Off	Color On/Off	Termination Resistor	Board ID	Component C On/Off	Color On/Off	
OFF	ON	ON	ON	ON	OFF	OFF	ON	4 catalyst valves, 25 color valves
OFF	ON	OFF	ON	ON	OFF	OFF	ON	0 catalyst valves, 25 color valves
OFF	ON	ON	ON	ON	OFF	ON	ON	4 catalyst valves, 4 component C valves, 25 color valves
OFF	ON	OFF	ON	ON	OFF	ON	ON	4 component C valves, 25 color valves
One Color Change Board								
ON	ON	ON	ON	NOT PRESENT				4 catalyst valves, 12 color valves
ON	ON	ON	OFF					4 catalyst valves, 0 color valves
ON	ON	OFF	ON					0 catalyst valves, 12 color valves

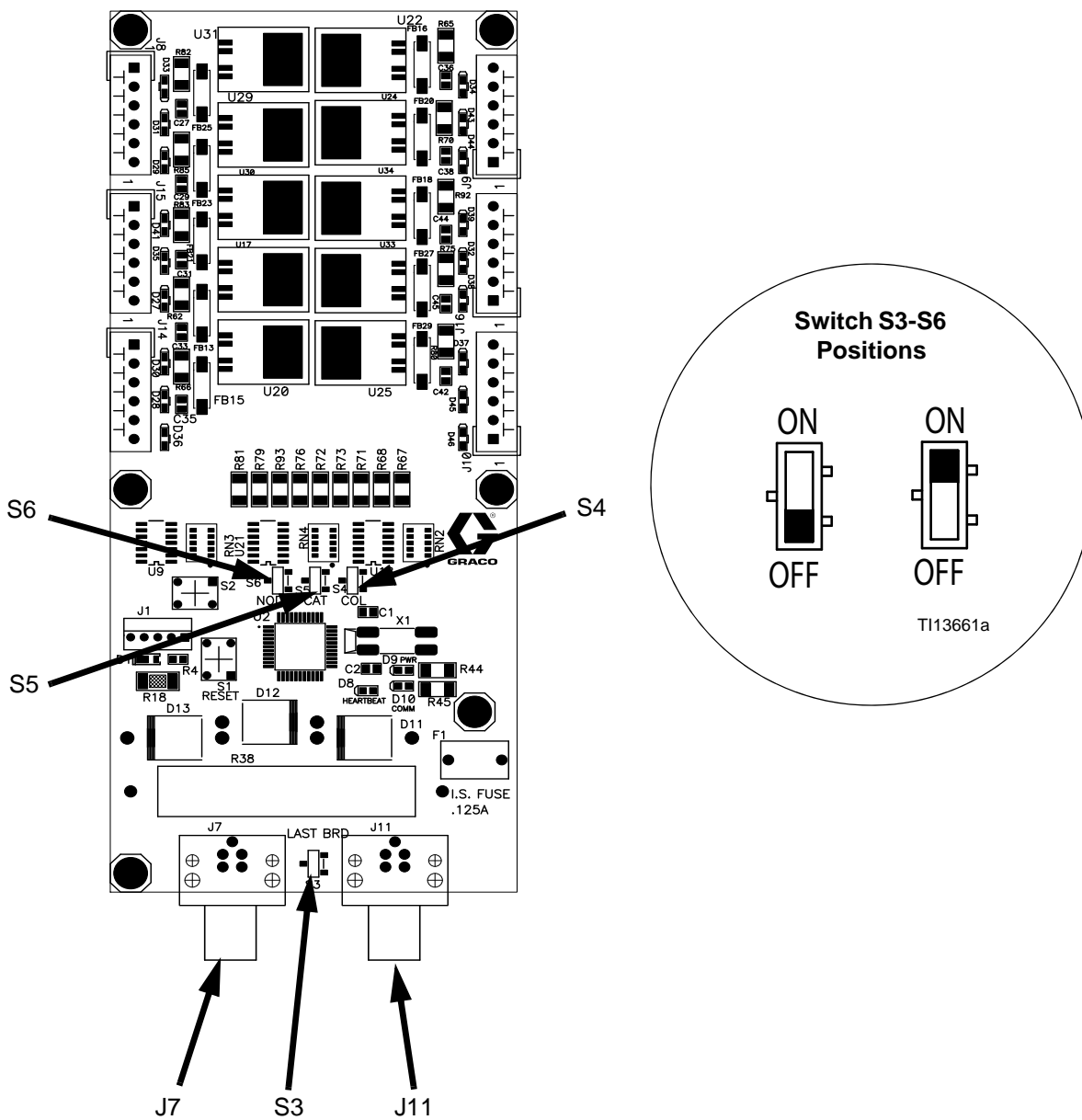

Fig. 16. Color Change Board Switches S3-S6

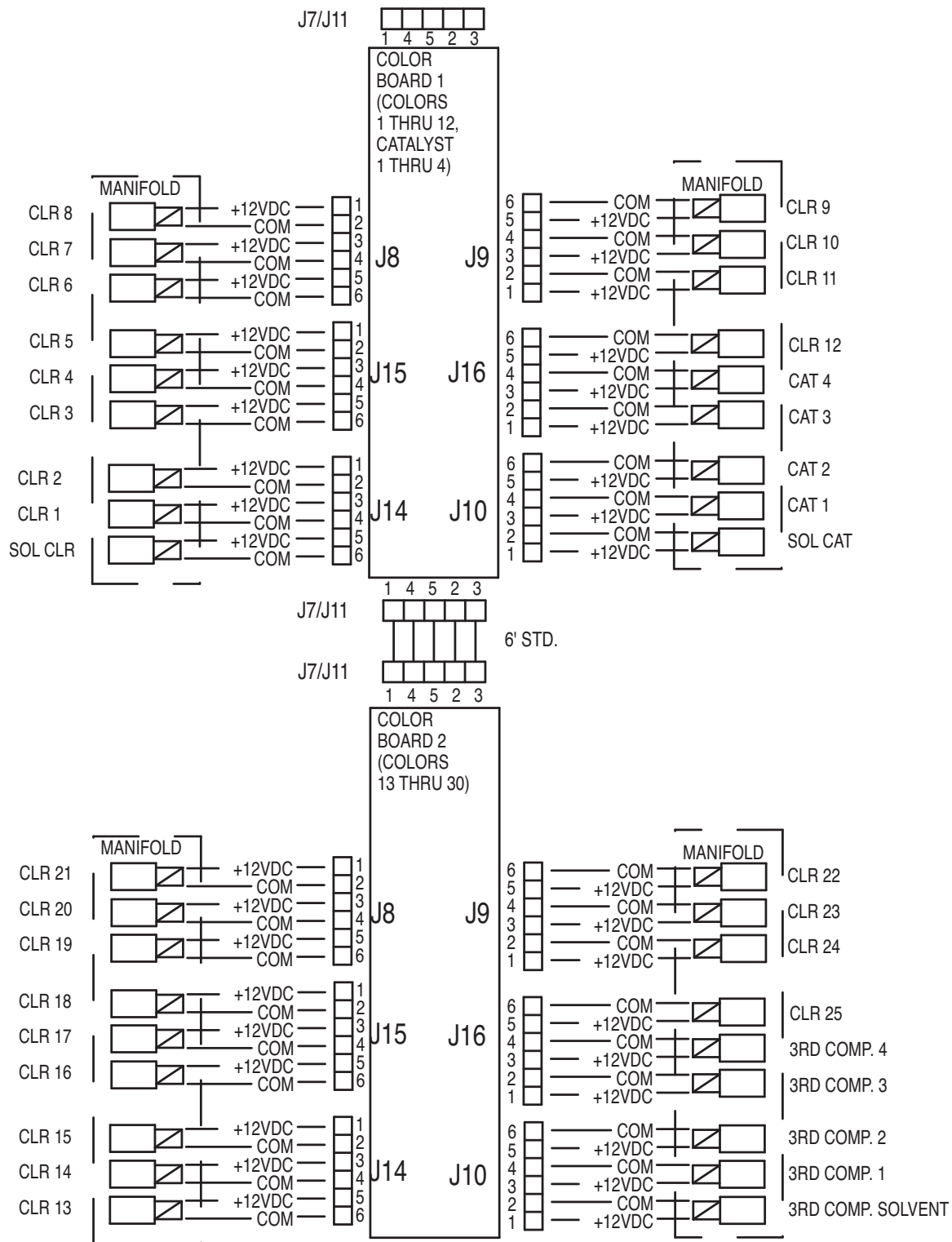





FIG. 17. Color Change Module Electrical Schematic

Grounding

						
<p>Your system must be grounded. Read Warnings, page 6. For intrinsic safety, ground wires for the EasyKey, Power Supply Module, 2KS Fluid Station, 3KS Fluid Station, Booth Control, and Gun Flush Box must all be connected to the same true earth ground. See FIG. 18, page 33.</p>						

Ground the ProMix system as instructed here and in the individual component manuals. A ground wire and clamp, part no. 223547, is available from Graco.

NOTE: Different ground points (unequal potential) may cause current to flow through component cables, causing incorrect signals.

EasyKey

Connect a ground wire from the EasyKey ground screw to a true earth ground. FIG. 18.

3KS Power Supply Module

Connect a ground wire from the 3KS Power Supply Module ground screw to a true earth ground. FIG. 18.

Booth Control

The Booth Control is grounded through the power cable connection to the fluid station. FIG. 18.

Gun Flush Box

Connect a ground wire from the Gun Flush Box ground lug to a true earth ground. FIG. 18.

2KS Wall Mount Fluid Station

Connect a ground wire from the 2KS Wall Mount Fluid Station ground screw to a true earth ground. FIG. 18.

3KS Wall Mount Fluid Station

Connect a ground wire from the 3KS Wall Mount Fluid Station ground screw to a true earth ground. FIG. 18.

Color Change Module

Connect a ground wire from the Color Change Module ground screw to a true earth ground. A ground wire and clamp, part no. 223547, is available from Graco. FIG. 18.

Flow Meters

Connect the meter cables as shown in the **System Electrical Schematic Hazardous Area** on page 38. Failure to properly connect the shield may cause incorrect signals.

Feed Pumps or Pressure Pots

Connect a ground wire and clamp from a true earth ground to the pumps or pots. See pump or pressure pot manual.

Air and Fluid Hoses

Use grounded hoses only.

Spray Gun

Follow the grounding instructions in your gun manual.

Fluid Supply Container

Follow local code.





Object Being Sprayed

Follow local code.

All Solvent Pails Used When Purging

Follow local code. Use only conductive metal pails/containers placed on a grounded surface. Do not place the pail/container on a nonconductive surface, such as paper or cardboard, which interrupts the grounding continuity.

Check Resistance

						
<p>To ensure proper grounding, resistance between ProMix components and true earth ground must be less than 1 ohm. Read Warnings, page 6.</p>						

Have a qualified electrician check resistance between each ProMix component and true earth ground. If resistance is greater than 1 ohm, a different ground site may be required. Do not operate the system until the problem is corrected.

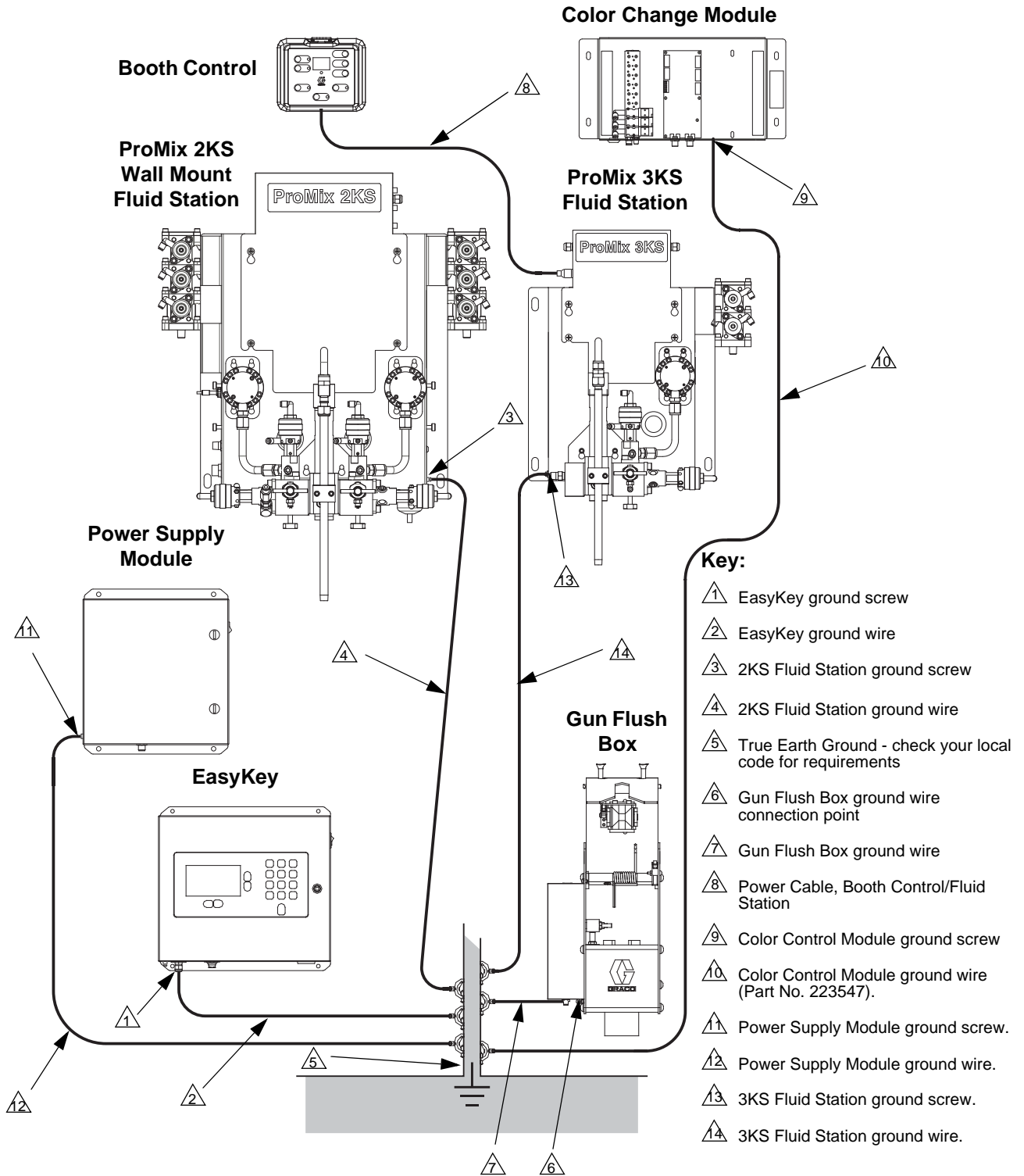

T114699a

NOTICE

Automatic systems: To prevent electrical noise interference from high voltage equipment, do not connect the robot ground to the same ground point used by these ProMix 3KS components.

Fig. 18: Grounding

Schematic Diagrams

System Pneumatic Schematic

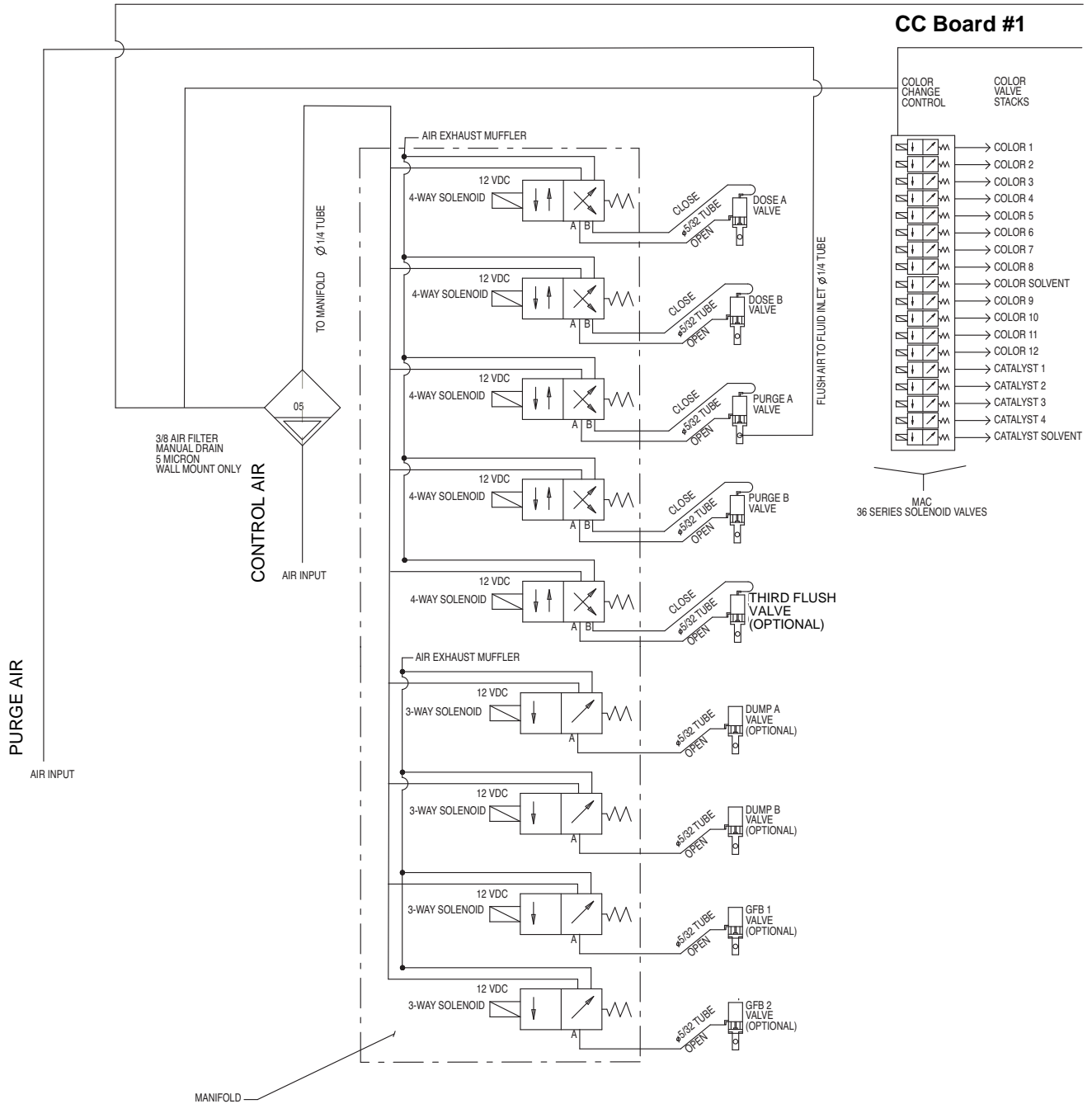

System Pneumatic Schematic

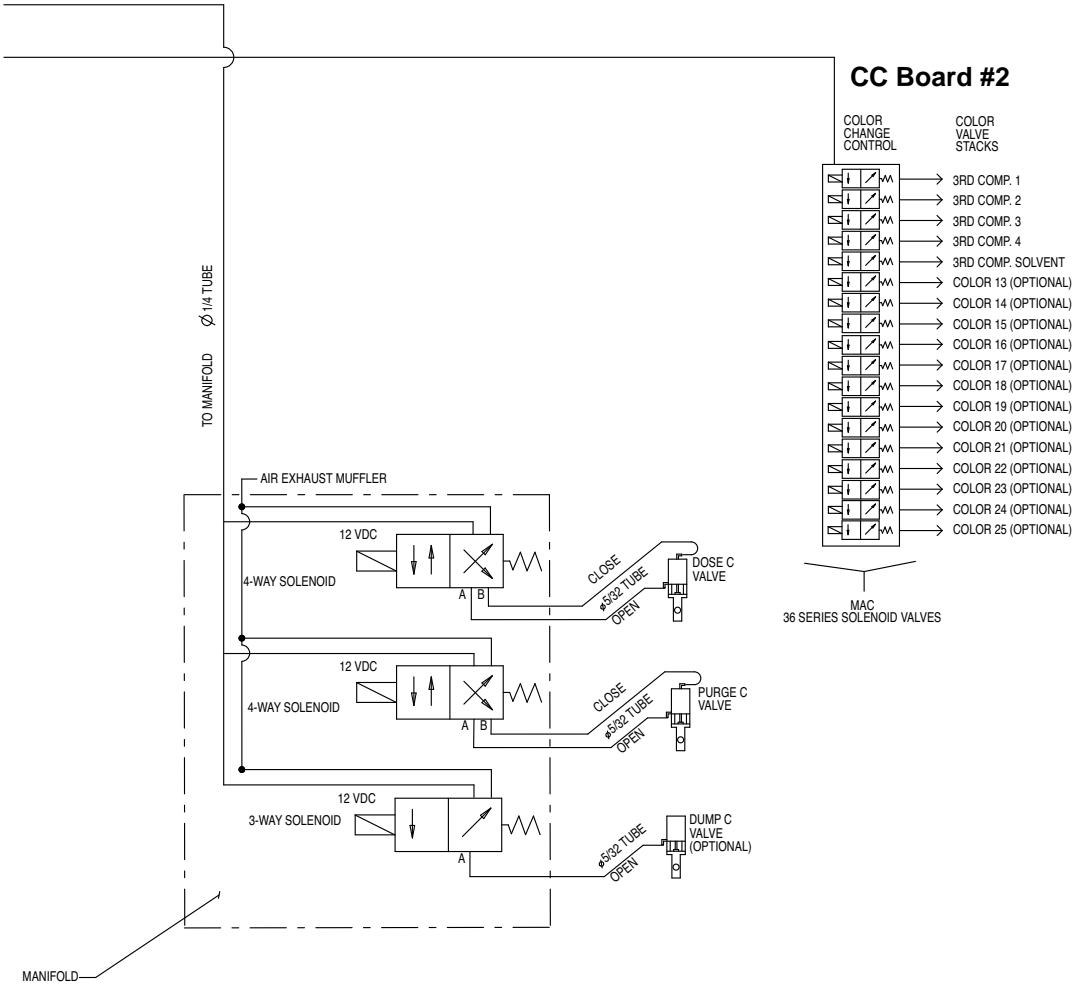

System Electrical Schematic

NOTE: The electrical schematic illustrates all possible wiring expansions in a ProMix 3KS system. Some components shown are not included with all systems.

Non-Hazardous Area

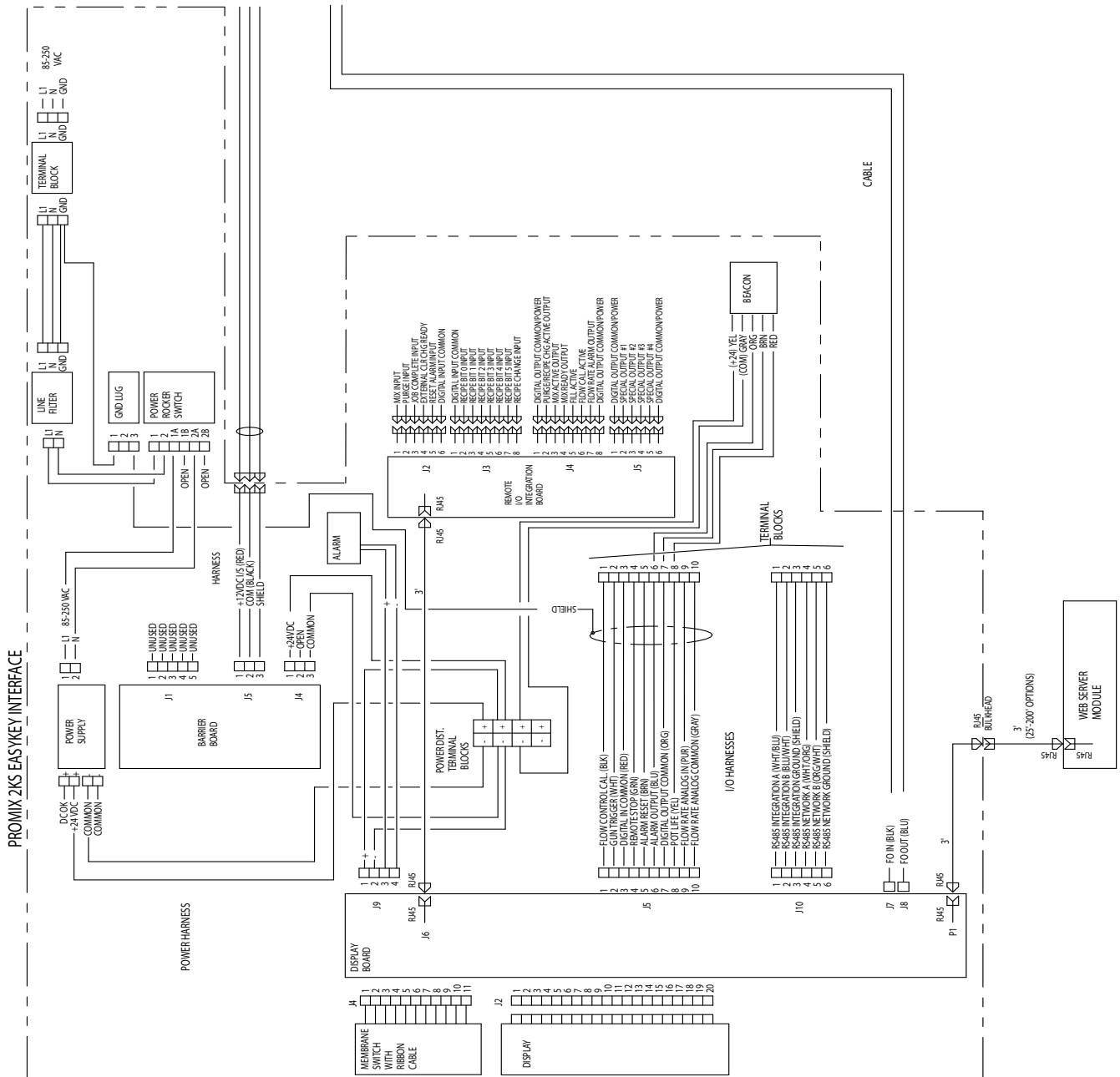

System Electrical Schematic

NOTE: The electrical schematic illustrates all possible wiring expansions in a ProMix 3KS system. Some components shown are not included with all systems.

Non-Hazardous Area

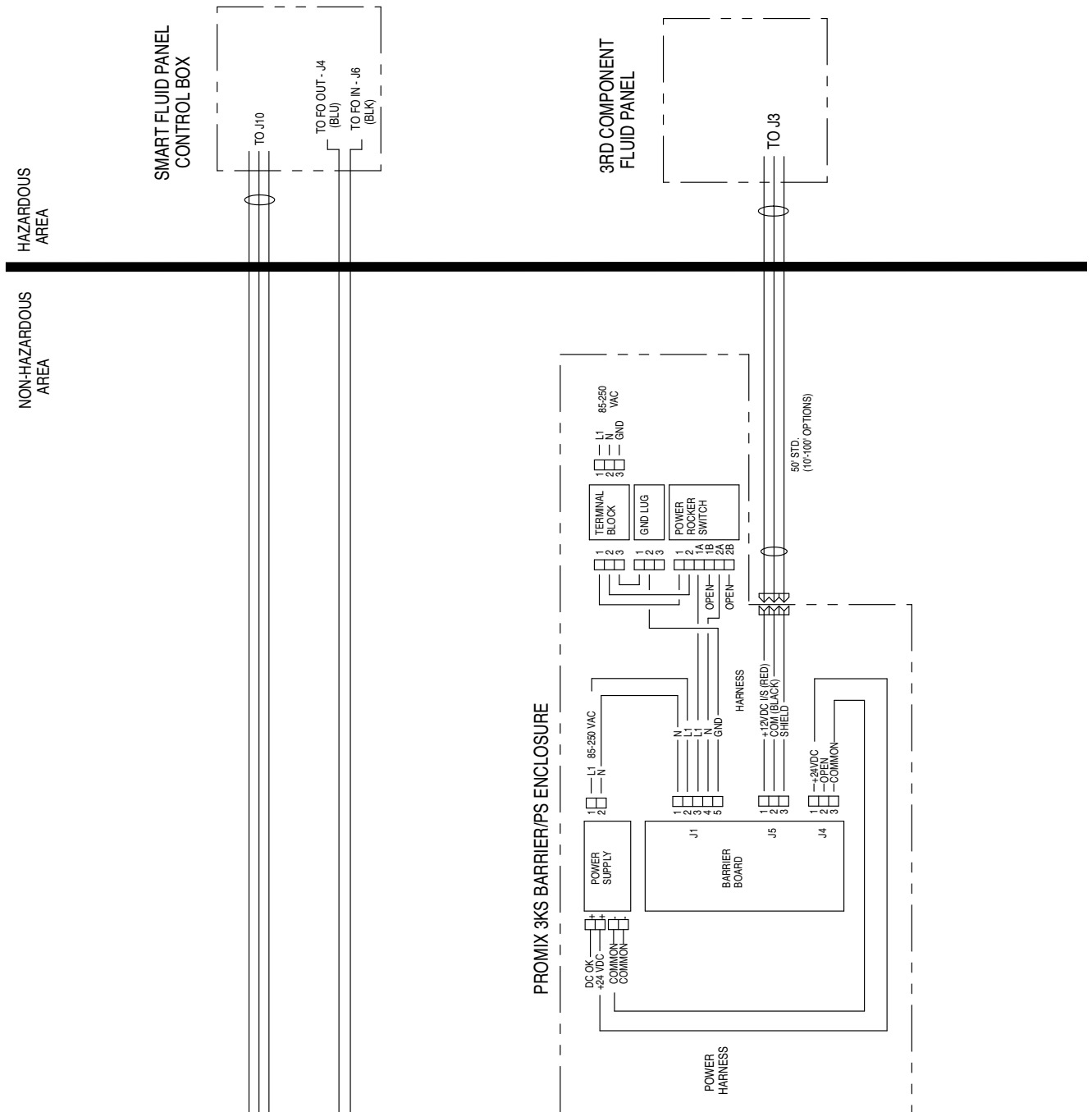

System Electrical Schematic

NOTE: The electrical schematic illustrates all possible wiring expansions in a ProMix 3KS system. Some components shown are not included with all systems.

Hazardous Area

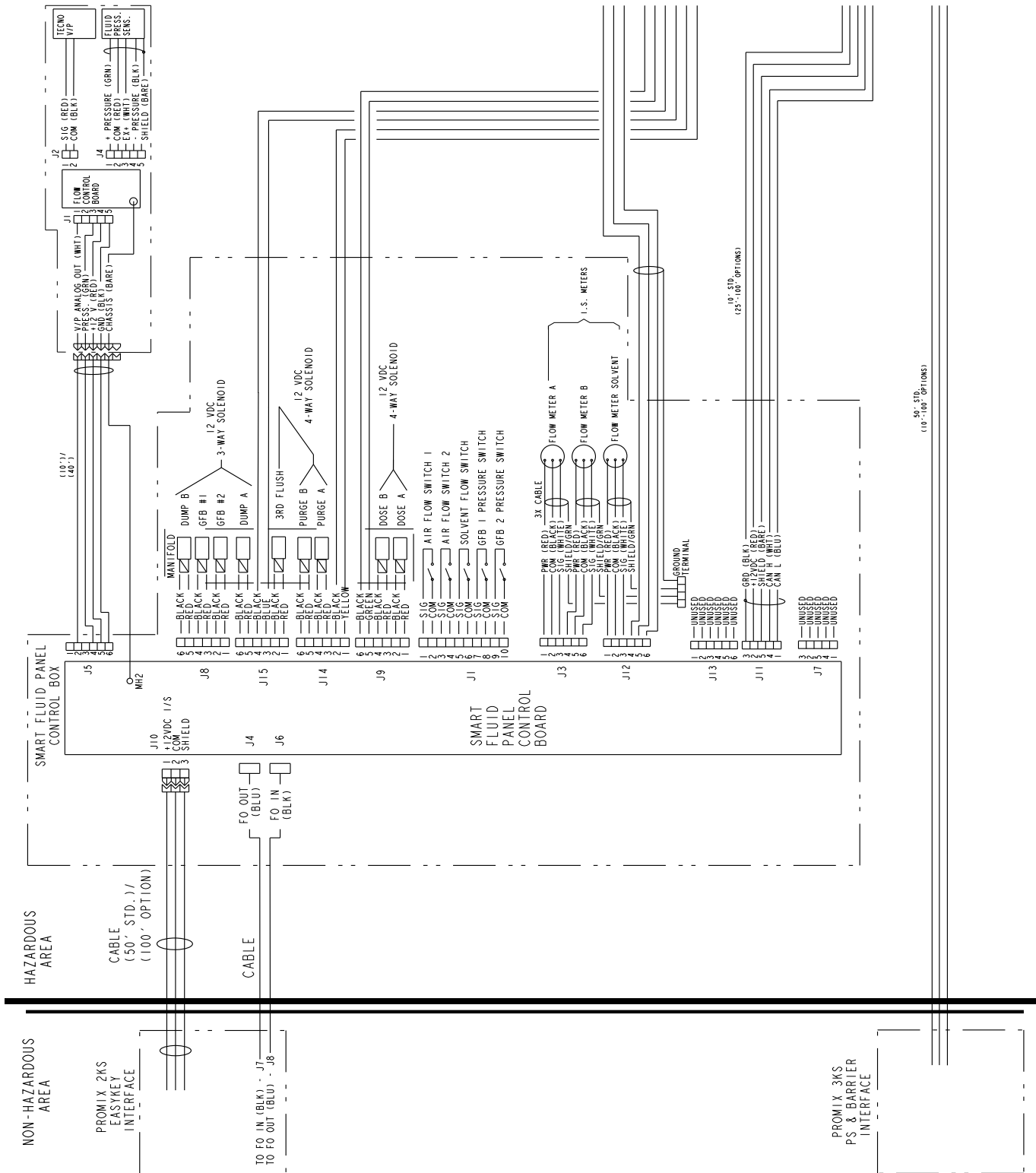

System Electrical Schematic

NOTE: The electrical schematic illustrates all possible wiring expansions in a ProMix 3KS system. Some components shown are not included with all systems.

Hazardous Area

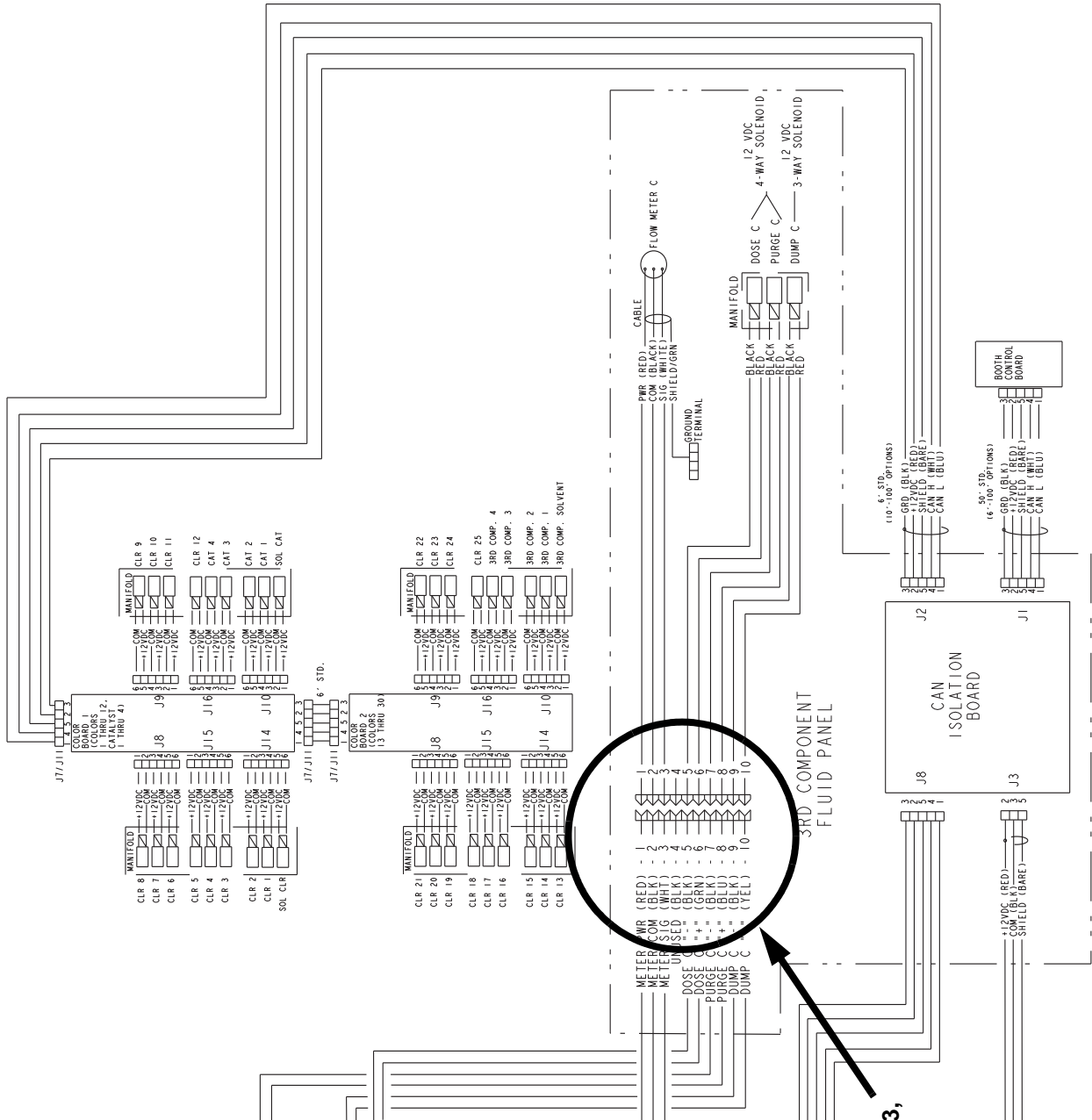

See Table 3,
page 26.

Dimensions and Mounting Hole Layouts

NOTE: See the table on page 41.

3KS Wall Mount Fluid Station

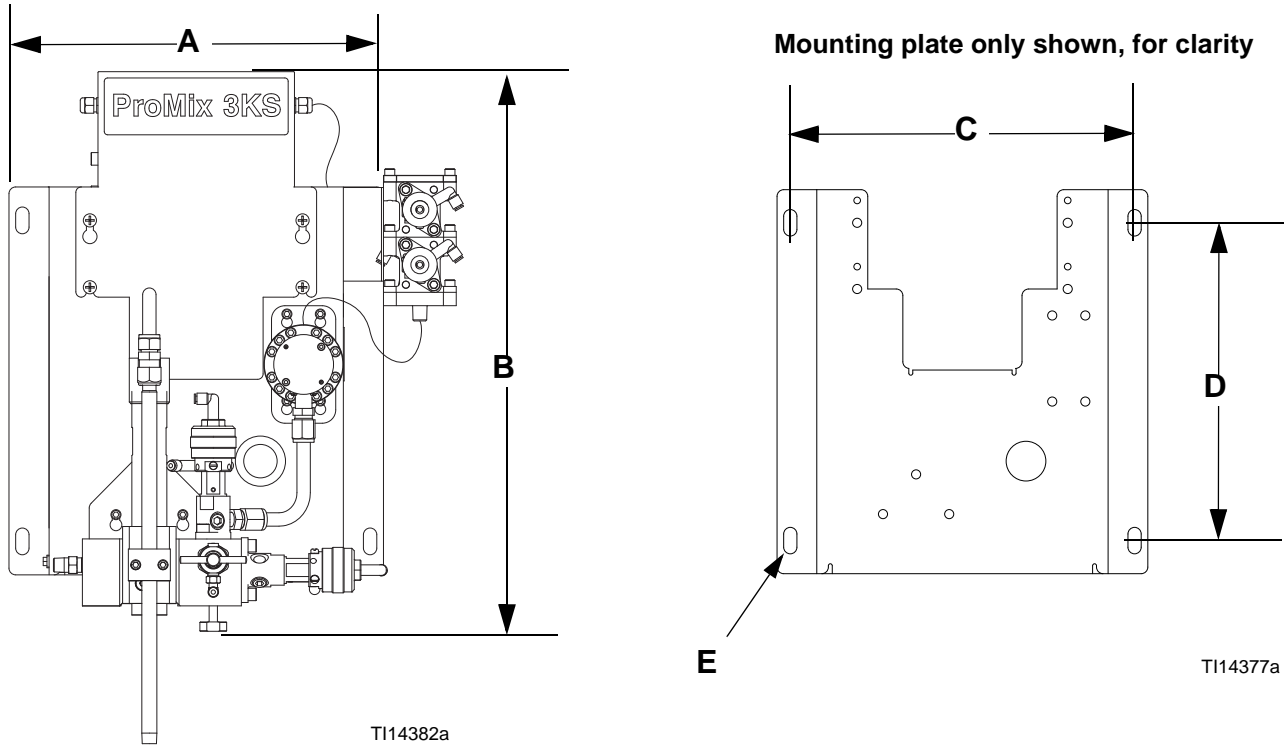

NOTE: Height is shown from top of panel to fluid shutoff valves, and does not include the effect of variable fluid integrator heights. Width of panel does not include optional color/component C valve stacks.

Power Supply Module

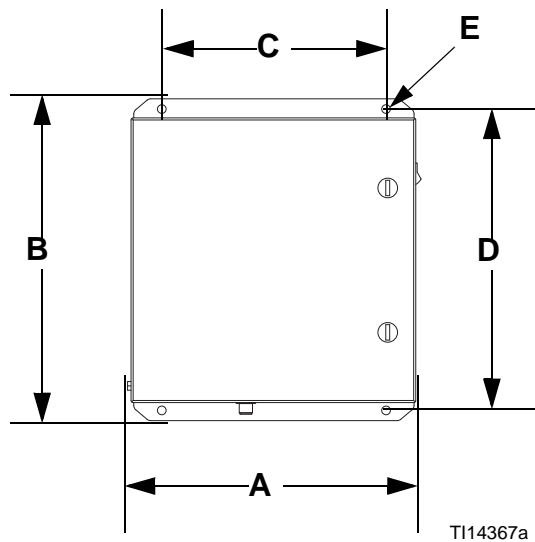

Module	A Overall Width in. (mm)	Overall Depth in. (mm)	B Overall Height in. (mm)	Mounting Dimensions, Width (C) x Height (D) in. (mm)	E Mounting Hole Size in. (mm)	Weight lb (kg)
3KS Wall Panel	14.0 (355.6)	11.0 (279.4)	18.8 (477.5)	13.0 x 12.0 (330.2 x 304.8)	0.5 (12.7)	50 (22.7)
Power Supply Module	10.2 (259.1)	6.7 (167.6)	11.5 (292.1)	8.0 x 10.75 (203.2 x 273.1)	0.3 (7.6)	22.2 (10.1)
EasyKey	See ProMix 2KS installation manual.					
2KS Wall Panel	See ProMix 2KS installation manual.					
Booth Control	See ProMix 2KS installation manual.					
Booth Control Mounting Bracket	See ProMix 2KS installation manual.					
Flow Control Module (automatic systems only)	See ProMix 2KS installation manual.					
Gun Flush Box	See Gun Flush Box manual 312784.					
Color Change Control Module	See Color Change Module manual 312787.					

California Proposition 65

CALIFORNIA RESIDENTS

 **WARNING:** Cancer and reproductive harm. – www.P65warnings.ca.gov.

Technical Data

Maximum fluid working pressure	<i>Base system:</i> 3000 psi (21 MPa, 210 bar) <i>Low pressure color change:</i> 300 psi (2.1 MPa, 21 bar) <i>High pressure color change:</i> 3000 psi (21 MPa, 210 bar) <i>Coriolis meter:</i> 2300 psi (16.1 MPa, 161 bar)
Maximum working air pressure	100 psi (0.7 MPa, 7 bar)
Air supply	75 - 100 psi (0.5 - 0.7 MPa, 5.2 - 7 bar)
Air filter inlet size	3/8 npt(f)
Air filtration for air logic and purge air (Graco-supplied) . .	5 micron (minimum) filtration required; clean and dry air
Air filtration for atomizing air (user-supplied)	30 micron (minimum) filtration required; clean and dry air
Mixing ratio range	Stage 1 (A:B): 0.1:1- 50:1* Stage 2 (A+B:C): 0.1:1- 50:1*
On-ratio accuracy	up to \pm 1%, user selectable
Fluids handled	one or two component: <ul style="list-style-type: none"> • solvent and waterborne paints • polyurethanes • epoxies • acid catalyzed varnishes • moisture sensitive isocyanates
Viscosity range of fluid	20- 5000 cps*
Fluid filtration (user-supplied)	100 mesh minimum
Fluid flow rate range*	
G3000, G250 Meter	75 - 3800 cc/min. (0.02-1.00 gal./min.)
G3000HR, G250HR Meter	38 - 1900 cc/min. (0.01-0.50 gal./min.)
Coriolis Meter	20 - 3800 cc/min. (0.005-1.00 gal./min.)
S3000 Solvent Meter (accessory)	38 - 1900 cc/min. (0.01-0.50 gal./min.)
Fluid inlet sizes	
Flow Meter	1/4 npt(f)
Dose Valve/Color Valve Adapters	1/4 npt(f)
3KS Fluid Station	1/4 npt(m)
Fluid outlet size (static mixer)	1/4 npt(f)
External Power Supply Requirements	85 - 250 Vac, 50/60 Hz, 2 amps maximum draw 15 amp maximum circuit breaker required 8 to 14 AWG power supply wire gauge
Operating temperature range	41- 122° F (5-50° C)
Environmental Conditions Rating	indoor use, pollution degree (2), installation category II
Noise Level	
Sound pressure level	below 70 dBA
Sound power level	below 85 dBA
Wetted parts	303, 304 SST, Tungsten carbide (with nickel binder), perfluoroelastomer; PTFE

* Dependent on flow rate, dose size, and meter resolution.

See individual component manuals for additional technical data.

Graco Standard Warranty

Graco warrants all equipment referenced in this document which is manufactured by Graco and bearing its name to be free from defects in material and workmanship on the date of sale to the original purchaser for use. With the exception of any special, extended, or limited warranty published by Graco, Graco will, for a period of twelve months from the date of sale, repair or replace any part of the equipment determined by Graco to be defective. This warranty applies only when the equipment is installed, operated and maintained in accordance with Graco's written recommendations.

This warranty does not cover, and Graco shall not be liable for general wear and tear, or any malfunction, damage or wear caused by faulty installation, misapplication, abrasion, corrosion, inadequate or improper maintenance, negligence, accident, tampering, or substitution of non-Graco component parts. Nor shall Graco be liable for malfunction, damage or wear caused by the incompatibility of Graco equipment with structures, accessories, equipment or materials not supplied by Graco, or the improper design, manufacture, installation, operation or maintenance of structures, accessories, equipment or materials not supplied by Graco.

This warranty is conditioned upon the prepaid return of the equipment claimed to be defective to an authorized Graco distributor for verification of the claimed defect. If the claimed defect is verified, Graco will repair or replace free of charge any defective parts. The equipment will be returned to the original purchaser transportation prepaid. If inspection of the equipment does not disclose any defect in material or workmanship, repairs will be made at a reasonable charge, which charges may include the costs of parts, labor, and transportation.

THIS WARRANTY IS EXCLUSIVE, AND IS IN LIEU OF ANY OTHER WARRANTIES, EXPRESS OR IMPLIED, INCLUDING BUT NOT LIMITED TO WARRANTY OF MERCHANTABILITY OR WARRANTY OF FITNESS FOR A PARTICULAR PURPOSE.

Graco's sole obligation and buyer's sole remedy for any breach of warranty shall be as set forth above. The buyer agrees that no other remedy (including, but not limited to, incidental or consequential damages for lost profits, lost sales, injury to person or property, or any other incidental or consequential loss) shall be available. Any action for breach of warranty must be brought within two (2) years of the date of sale.

GRACO MAKES NO WARRANTY, AND DISCLAIMS ALL IMPLIED WARRANTIES OF MERCHANTABILITY AND FITNESS FOR A PARTICULAR PURPOSE, IN CONNECTION WITH ACCESSORIES, EQUIPMENT, MATERIALS OR COMPONENTS SOLD BUT NOT MANUFACTURED BY GRACO. These items sold, but not manufactured by Graco (such as electric motors, switches, hose, etc.), are subject to the warranty, if any, of their manufacturer. Graco will provide purchaser with reasonable assistance in making any claim for breach of these warranties.

In no event will Graco be liable for indirect, incidental, special or consequential damages resulting from Graco supplying equipment hereunder, or the furnishing, performance, or use of any products or other goods sold hereto, whether due to a breach of contract, breach of warranty, the negligence of Graco, or otherwise.

FOR GRACO CANADA CUSTOMERS

The Parties acknowledge that they have required that the present document, as well as all documents, notices and legal proceedings entered into, given or instituted pursuant hereto or relating directly or indirectly hereto, be drawn up in English. Les parties reconnaissent avoir convenu que la rédaction du présente document sera en Anglais, ainsi que tous documents, avis et procédures judiciaires exécutés, donnés ou intentés, à la suite de ou en rapport, directement ou indirectement, avec les procédures concernées.

Graco Information

For the latest information about Graco products, visit www.graco.com.

For patent information, see www.graco.com/patents.

TO PLACE AN ORDER, contact your Graco distributor or call to identify the nearest distributor.

Phone: 612-623-6921 **or Toll Free:** 1-800-328-0211, **Fax:** 612-378-3505

All written and visual data contained in this document reflects the latest product information available at the time of publication. Graco reserves the right to make changes at any time without notice.

Original instructions. This manual contains English. MM 313881

Graco Headquarters: Minneapolis

International Offices: Belgium, China, Japan, Korea

GRACO INC. AND SUBSIDIARIES • P.O. BOX 1441 • MINNEAPOLIS MN 55440-1441 • USA

Copyright 2010, Graco Inc. is registered to ISO 9001

www.graco.com

Revision C, January 2021